



# TGF2978-SM

20 W, 32 V, DC to 12 GHz, GaN RF Transistor

## Product Overview

The Qorvo TGF2978-SM is a 20 W ( $P_{3dB}$ ) discrete GaN on SiC HEMT which operates from DC to 12 GHz and 32 V supply. The device is in an industry standard overmolded package and is ideally suited for avionics, military, marine and weather radar. The device can support pulsed and linear operations.

Lead-free and ROHS compliant.

Evaluation boards are available upon request.

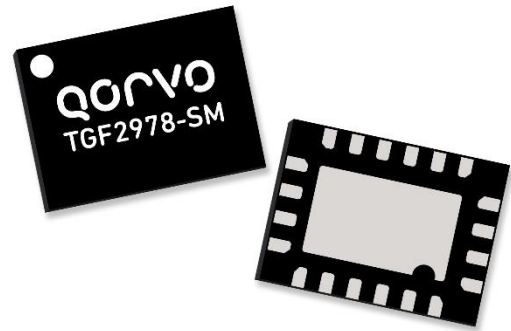

3 x 4mm Package

## Functional Block Diagram

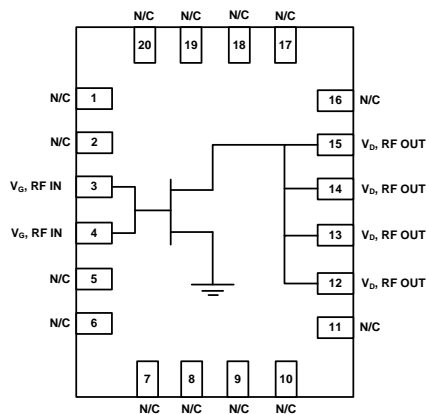

## Key Features

- Frequency Range: DC – 12 GHz
  - Output Power ( $P_{3dB}$ )<sup>1</sup>: 20 W
  - Typical PAE<sup>1</sup>: 45%
  - Linear Gain<sup>1</sup>: 9.5 dB
  - Operating Voltage: 32 V
  - CW and Pulse capable
- Note 1: @ 9 GHz

## Applications

- Military radar
- Commercial radar
  - Avionics
  - Marine
  - Weather

## Pad Configuration

Pad No.	Symbol
3 – 4	$V_G$ / RF IN
12 – 15	$V_D$ / RF OUT
Backside	Source / Ground

## Ordering Information

Part Number	Description
TGF2978-SM	QFN Packaged Part
TGF2978-SMEVB01	9 – 10 GHz EVB
TGF2978-SMEVB02	2.7 – 3.3 GHz EVB
TGF2978-SMEVB03	3.1 – 3.5 GHz EVB
TGF2978-SMEVB04	4 – 5 GHz EVB
TGF2978-SMEVB05	5 – 6 GHz EVB

## Absolute Maximum Ratings

Parameter	Rating
Drain to Gate Voltage ( $V_{DG}$ )	100 V
Gate Voltage Range ( $V_G$ )	-7 to +2 V
Drain Current ( $I_D$ )	0.6 A
Gate Current ( $I_G$ )	-5 to 8.4 mA
Power Dissipation, CW ( $P_D$ )	See graph on pg.4.
CW Input Power ( $P_{IN}$ )	+27.5 dBm
Storage Temperature	-65 to 150°C

Exceeding any one or a combination of the Absolute Maximum Rating conditions may cause permanent damage to the device. Extended application of Absolute Maximum Rating conditions to the device may reduce device reliability.

Note:

1. Pulse (20% Duty Cycle, 100  $\mu$ s Width)

## Recommended Operating Conditions

Parameter	Min	Typ	Max	Units
Drain Voltage Range ( $V_D$ )	-	+32	+40	V
Drain Quiescent Current ( $I_{DQ}$ )	-	100	-	mA
Gate Voltage, $V_G^1$	-3.5	-2.7	-2.0	V
Gate Leakage: $V_D = +10$ V, $V_G = -3.7$ V	-2.5	-	-	mA

Electrical specifications are measured at specified test conditions. Specifications are not guaranteed over all recommended operating conditions.

Note:

1. To be adjusted to desired  $I_{DQ}$

## Measured Load Pull Performance – Power Tuned<sup>1</sup>

Test conditions unless otherwise noted: T = 25°C, Pulse (20% Duty Cycle, 100  $\mu$ s Width).

Parameter	Typical Values					Units
	5	6	8	9	10	
Frequency, F	5	6	8	9	10	GHz
Drain Voltage, $V_D$	32	32	32	32	32	V
Drain Bias Current, $I_{DQ}$	100	100	100	100	100	mA
Output Power at 3dB compression, $P_{3dB}$	43.8	43.7	43.4	43.1	42.8	dBm
Power Added Efficiency at 3dB compression, $PAE_{3dB}$	50.7	50.1	44.6	37.0	35.4	%
Gain at 3dB compression, $G_{3dB}$	13.4	11.9	8.1	6.5	5.7	dB

Notes:

1. Characteristic Impedance,  $Z_0 = 15 \Omega$ .

## Measured Load Pull Performance – Efficiency Tuned<sup>1</sup>

Test conditions unless otherwise noted: T = 25°C, Pulse (20% Duty Cycle, 100  $\mu$ s Width).

Parameter	Typical Values					Units
	5	6	8	9	10	
Frequency, F	5	6	8	9	10	GHz
Drain Voltage, $V_D$	32	32	32	32	32	V
Drain Bias Current, $I_{DQ}$	100	100	100	100	100	mA
Output Power at 3dB compression, $P_{3dB}$	42.4	42.6	42.5	42.2	42.4	dBm
Power Added Efficiency at 3dB compression, $PAE_{3dB}$	60.0	58.0	51.3	45.4	39.8	%
Gain at 3dB compression, $G_{3dB}$	14.5	12.4	8.8	7.3	6.1	dB

Notes:

1. Characteristic Impedance,  $Z_0 = 15 \Omega$ .

### Thermal and Reliability Information - CW <sup>(1)</sup>

Parameter	Test Conditions	Value	Units
Thermal Resistance, Peak IR Surface Temperature at Average Power ( $\theta_{JC}$ )	$P_{DISS} = 30.2 \text{ W}$ , $T_{baseplate} = 85^\circ\text{C}$	5.9	$^\circ\text{C/W}$
Channel Temperature, $T_{CH}$		263	$^\circ\text{C}$
Thermal Resistance, Peak IR Surface Temperature at Average Power ( $\theta_{JC}$ )	$P_{DISS} = 25.5 \text{ W}$ , $T_{baseplate} = 85^\circ\text{C}$	5.6	$^\circ\text{C/W}$
Channel Temperature, $T_{CH}$		227	$^\circ\text{C}$
Thermal Resistance, Peak IR Surface Temperature at Average Power ( $\theta_{JC}$ )	$P_{DISS} = 20.2 \text{ W}$ , $T_{baseplate} = 85^\circ\text{C}$	5.2	$^\circ\text{C/W}$
Channel Temperature, $T_{CH}$		191	$^\circ\text{C}$
Thermal Resistance, Peak IR Surface Temperature at Average Power ( $\theta_{JC}$ )	$P_{DISS} = 15.1 \text{ W}$ , $T_{baseplate} = 85^\circ\text{C}$	5.0	$^\circ\text{C/W}$
Channel Temperature, $T_{CH}$		160	$^\circ\text{C}$

Notes:

1. Assumes eutectic attach using 1.5mil thick 80/20 AuSn mounted to a 10 mm x 10 mm x 40 mil CuMo Carrier Plate.
2. Refer to the following document: [GaN Device Channel Temperature, Thermal Resistance, and Reliability Estimates](#)

### Thermal and Reliability Information - Pulsed <sup>(1)</sup>

Parameter	Test Conditions	Value	Units
Thermal Resistance, Peak IR Surface Temperature at Average Power ( $\theta_{JC}$ )	$P_{DISS} = 30.2 \text{ W}$ , $T_{baseplate} = 85^\circ\text{C}$ Pulse Width = 100 $\mu\text{s}$	2.73	$^\circ\text{C/W}$
Channel Temperature, $T_{CH}$		Duty Cycle = 10%	167
Thermal Resistance, Peak IR Surface Temperature at Average Power ( $\theta_{JC}$ )	$P_{DISS} = 25.2 \text{ W}$ , $T_{baseplate} = 85^\circ\text{C}$ Pulse Width = 100 $\mu\text{s}$	2.68	$^\circ\text{C/W}$
Channel Temperature, $T_{CH}$		Duty Cycle = 10%	152

Notes:

1. Assumes eutectic attach using 1.5mil thick 80/20 AuSn mounted to a 10 mm x 10 mm x 40 mil CuMo Carrier Plate.
2. Refer to the following document: [GaN Device Channel Temperature, Thermal Resistance, and Reliability Estimates](#)

Maximum Channel Temperature

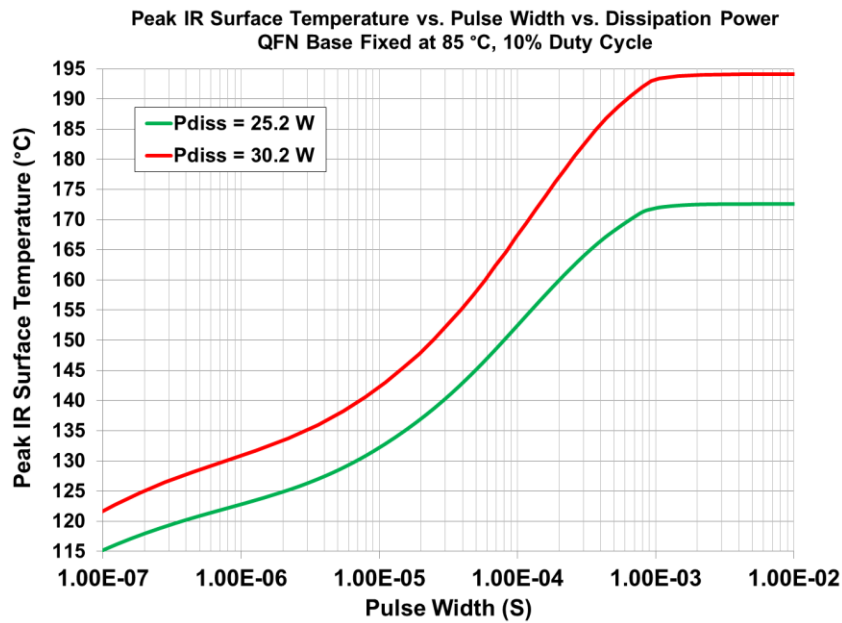
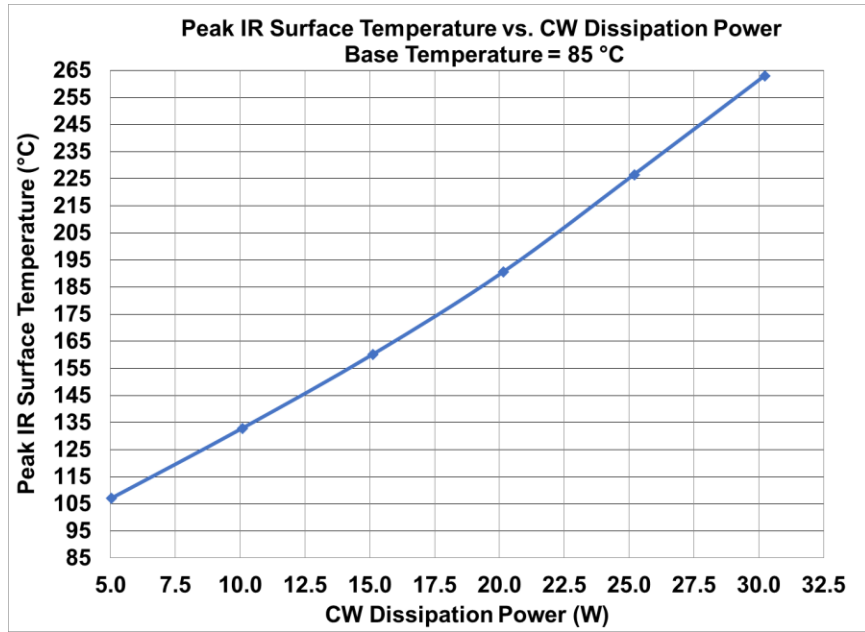

**Measured Load Pull Contours**

Test Conditions:  $V_D = +32V$ ,  $I_{DQ} = 100\text{ mA}$ ,  $T = +25^\circ\text{C}$ , Pulse (10% Duty Cycle, 100  $\mu\text{s}$  Width).

**5GHz, Load-pull**

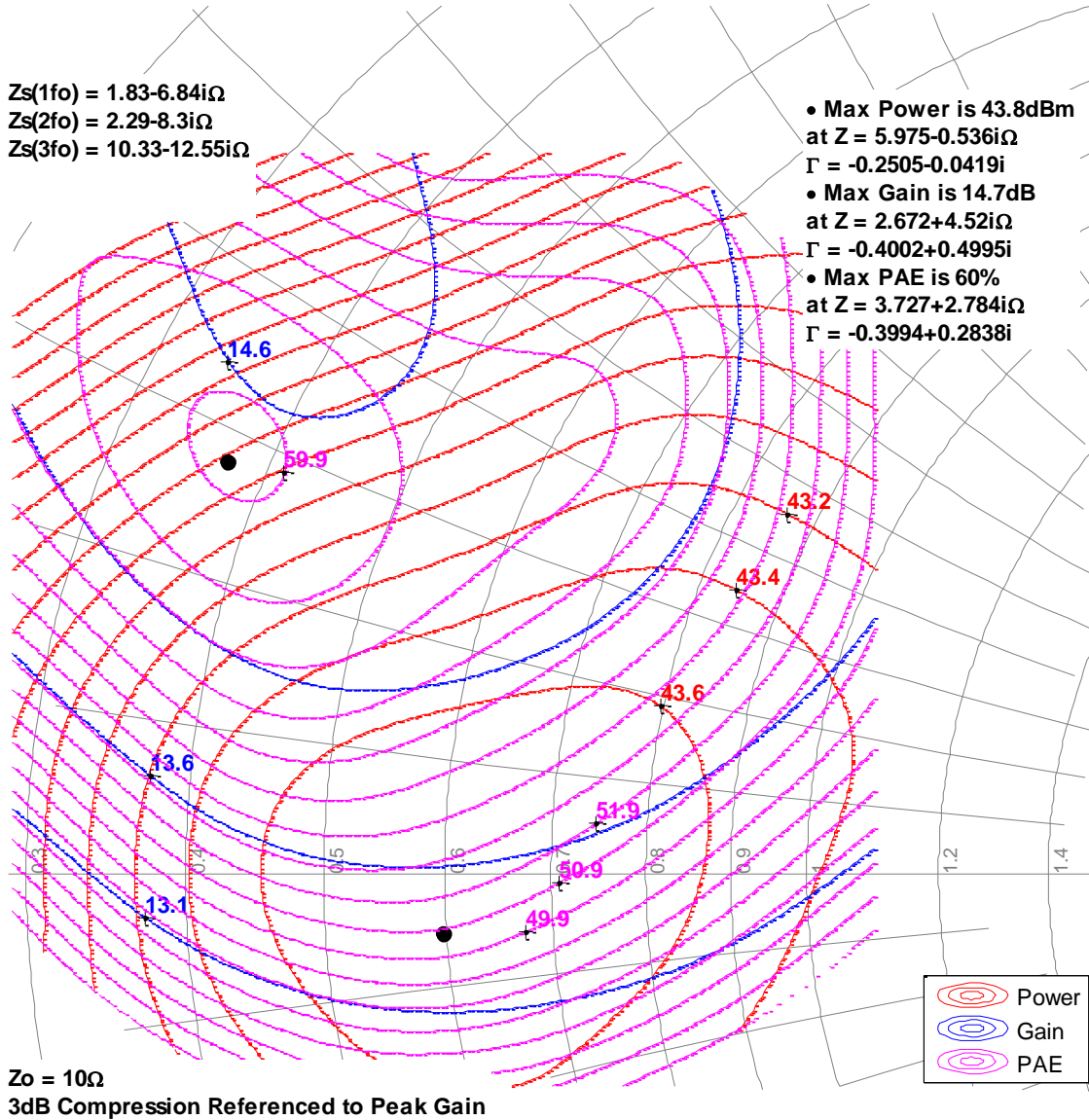

Measured Load Pull Contours

Test Conditions:  $V_D = +32V$ ,  $I_{DQ} = 100\text{ mA}$ ,  $T = +25^\circ\text{C}$ , Pulse (10% Duty Cycle, 100  $\mu\text{s}$  Width).

6GHz, Load-pull

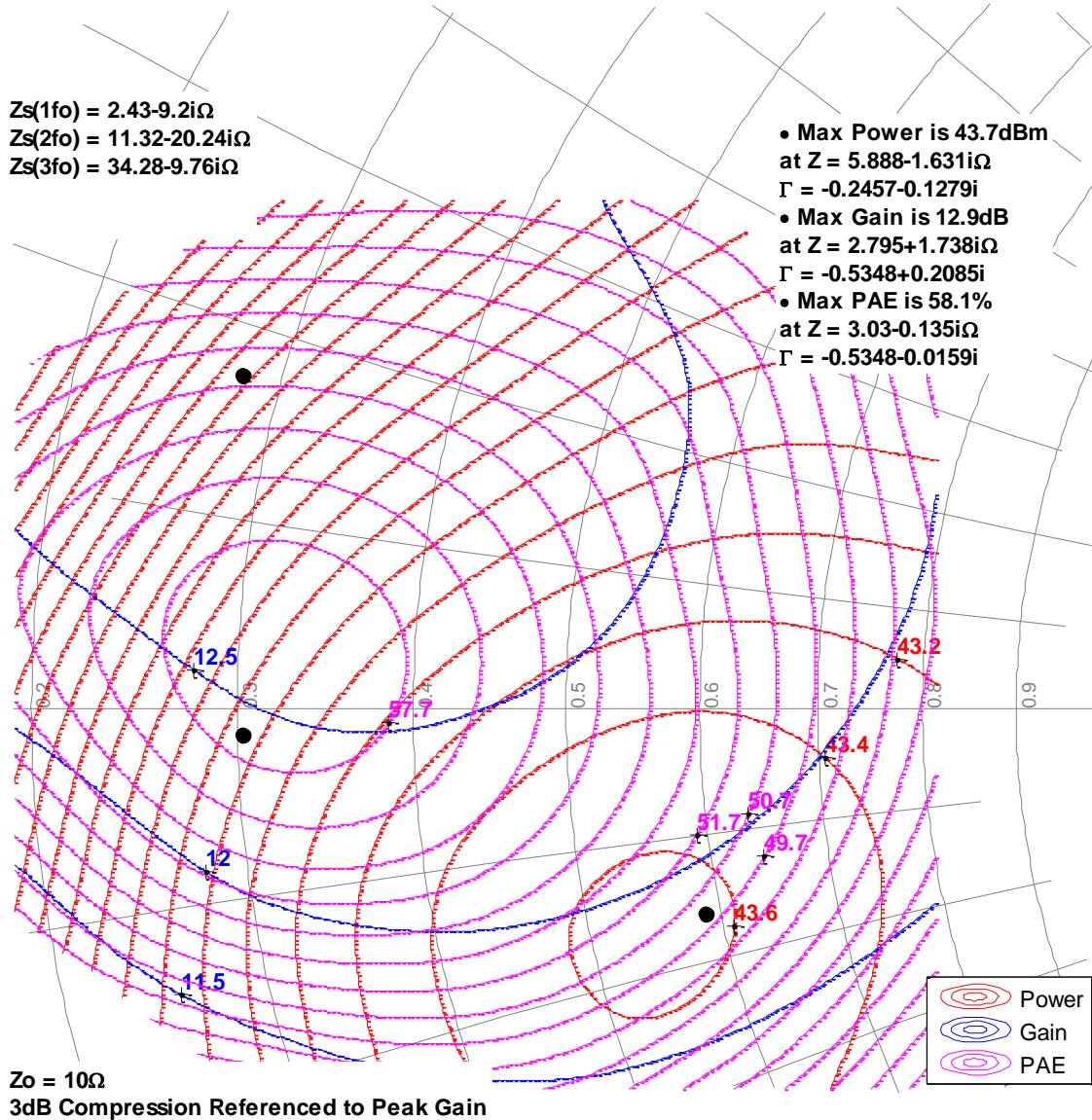

**Measured Load Pull Contours**

Test Conditions:  $V_D = +32V$ ,  $I_{DQ} = 100\text{ mA}$ ,  $T = +25^\circ\text{C}$ , Pulse (10% Duty Cycle, 100  $\mu\text{s}$  Width).

**8GHz, Load-pull**

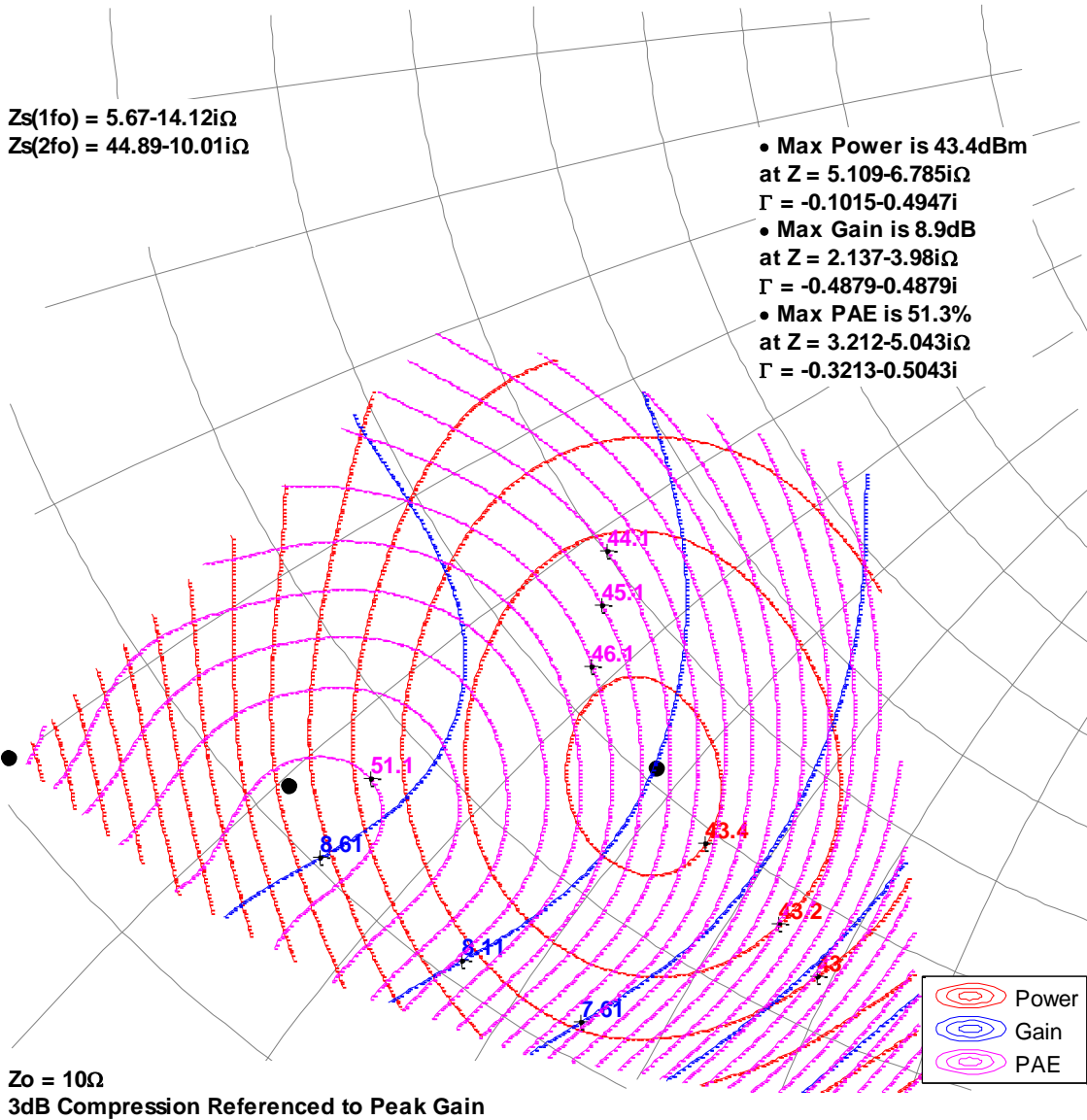

Measured Load Pull Contours

Test Conditions:  $V_D = +32V$ ,  $I_{DQ} = 100\text{ mA}$ ,  $T = +25^\circ\text{C}$ , Pulse (10% Duty Cycle, 100  $\mu\text{s}$  Width).

9GHz, Load-pull

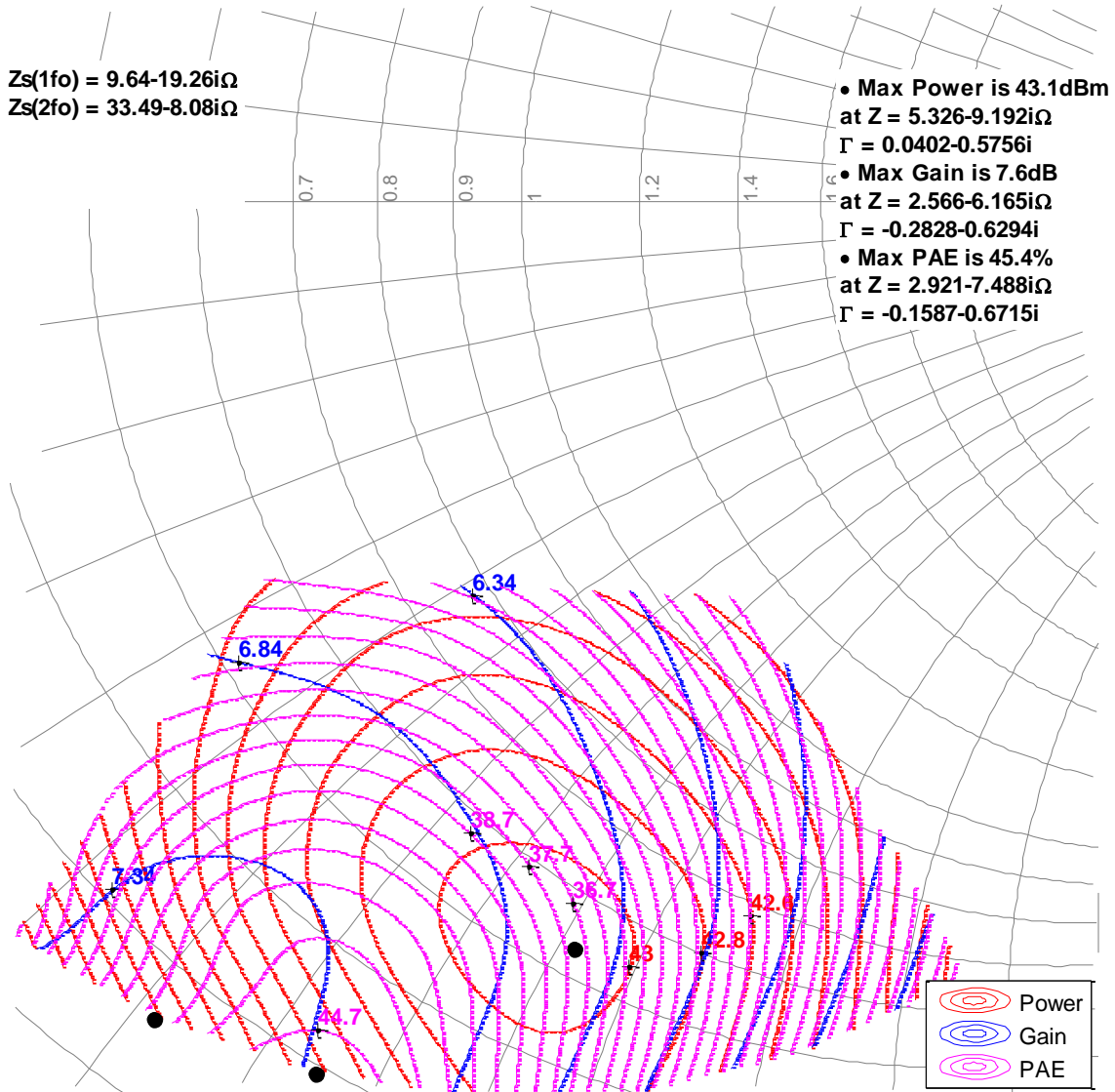

$Z_o = 10\Omega$   
3dB Compression Referenced to Peak Gain



**Measured Load Pull Contours**

Test Conditions:  $V_D = +32V$ ,  $I_{DQ} = 100\text{ mA}$ ,  $T = +25^\circ\text{C}$ , Pulse (10% Duty Cycle, 100  $\mu\text{s}$  Width).

**10GHz, Load-pull**

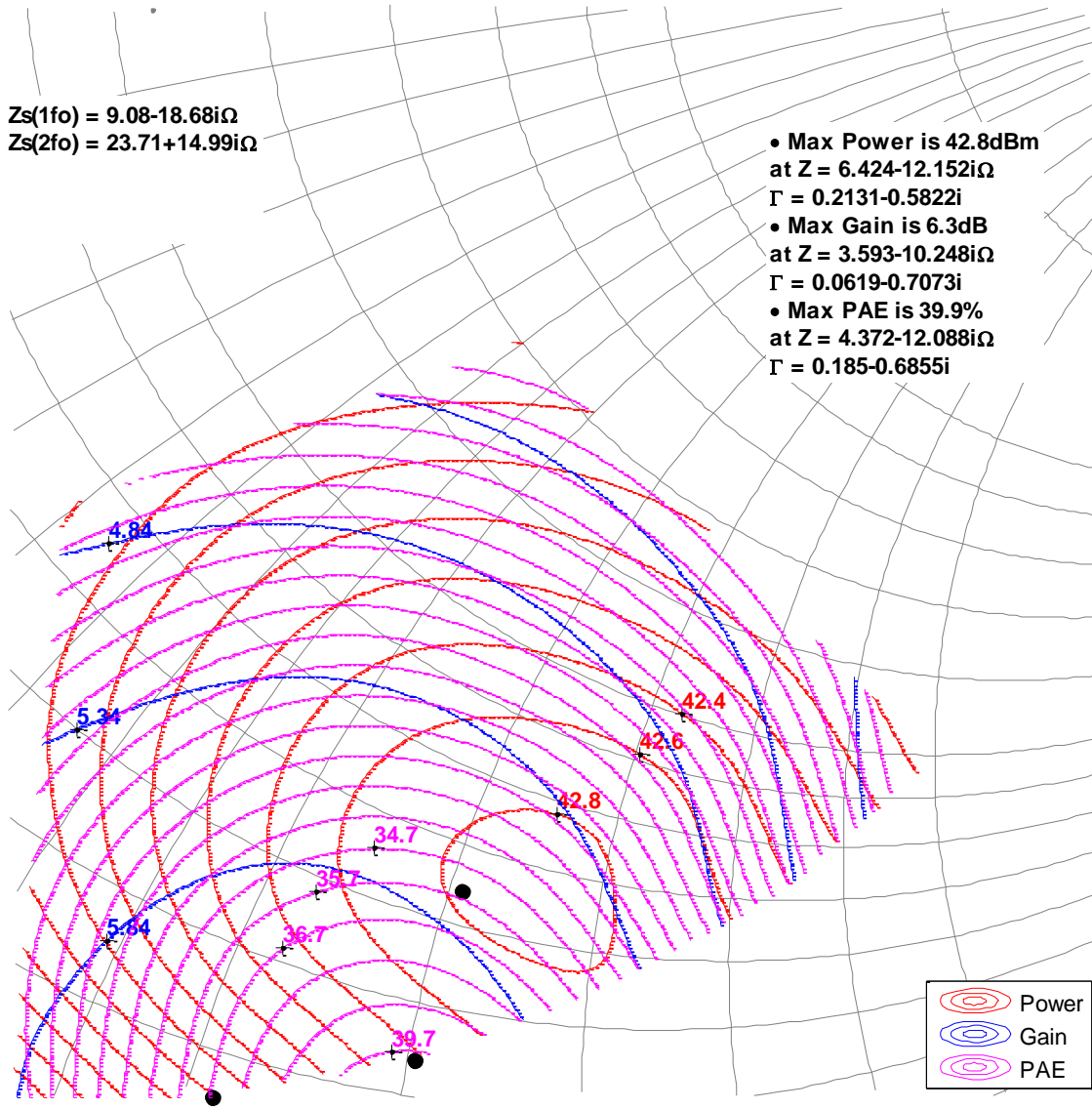

$Z_s(1fo) = 9.08-18.68i\Omega$   
 $Z_s(2fo) = 23.71+14.99i\Omega$

- Max Power is 42.8dBm at  $Z = 6.424-12.152i\Omega$   
 $\Gamma = 0.2131-0.5822i$
- Max Gain is 6.3dB at  $Z = 3.593-10.248i\Omega$   
 $\Gamma = 0.0619-0.7073i$
- Max PAE is 39.9% at  $Z = 4.372-12.088i\Omega$   
 $\Gamma = 0.185-0.6855i$

$Z_o = 10\Omega$   
 3dB Compression Referenced to Peak Gain

**Measured Load Pull Contours**

Test Conditions:  $V_D = +32V$ ,  $I_{DQ} = 100\text{ mA}$ ,  $T = +25^\circ\text{C}$ , Pulse (10% Duty Cycle, 100  $\mu\text{s}$  Width).

**12GHz, Load-pull**

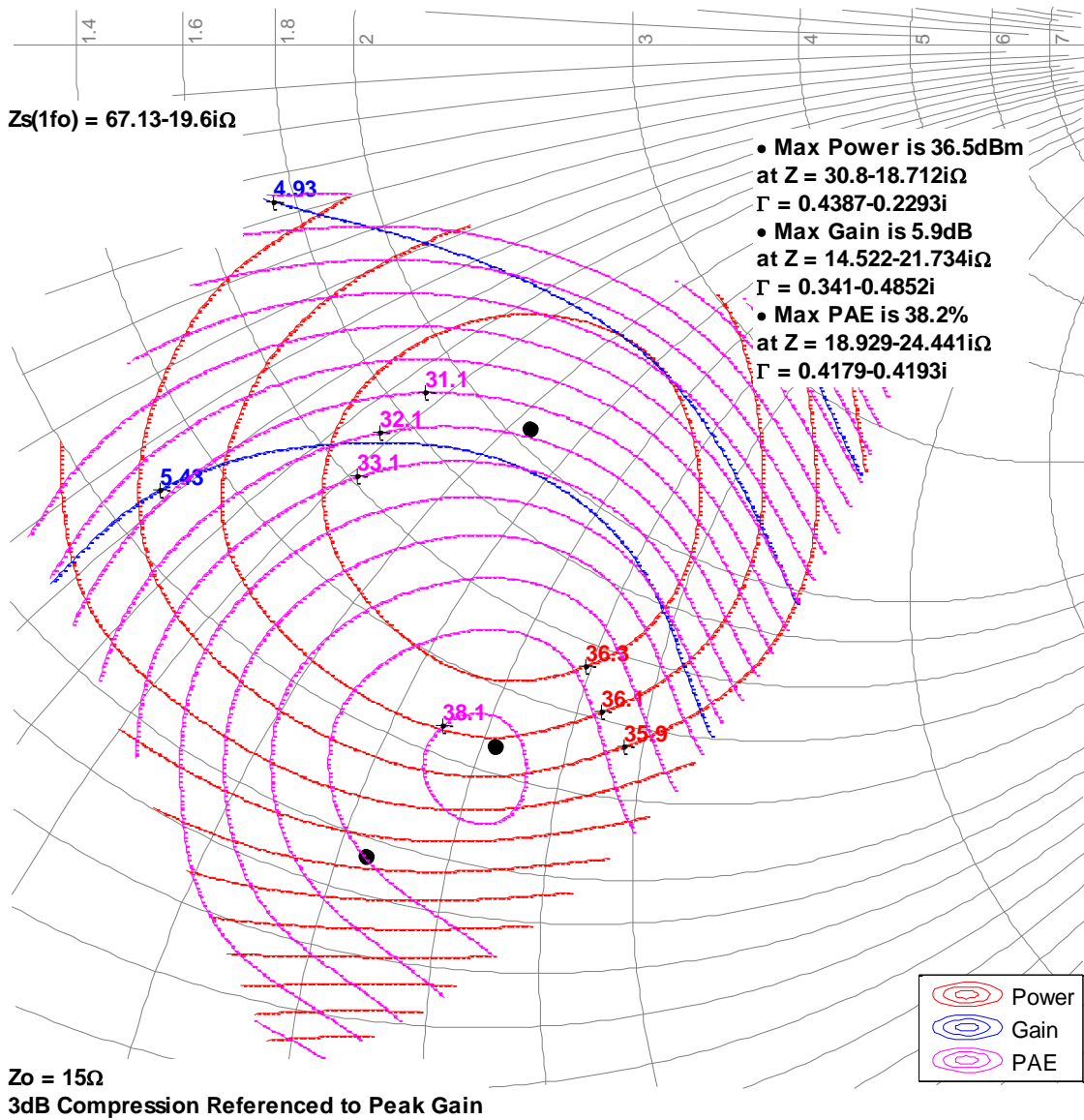

## Typical Measured Performance – Load-Pull Drive-up

Test Conditions:  $V_D = +32\text{ V}$ ,  $I_{DQ} = 25\text{ mA}$ ,  $T = +25^\circ\text{C}$ , Pulse (20% Duty Cycle, 100  $\mu\text{s}$  Width).

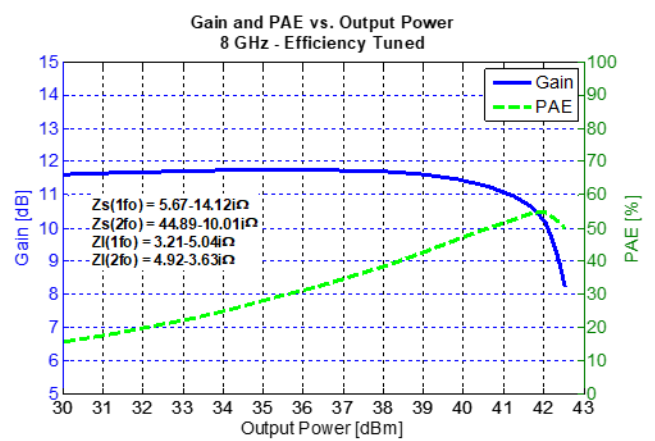
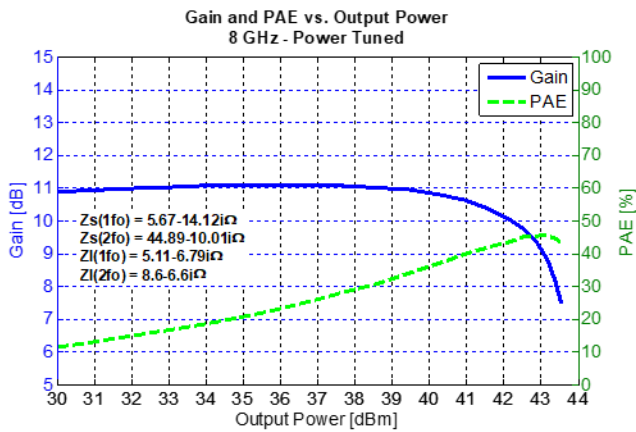
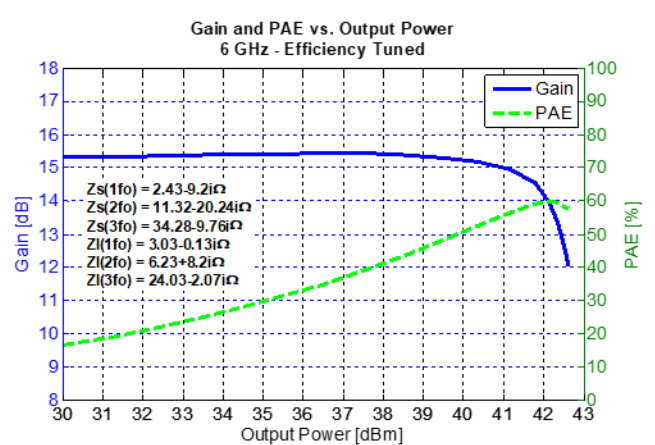
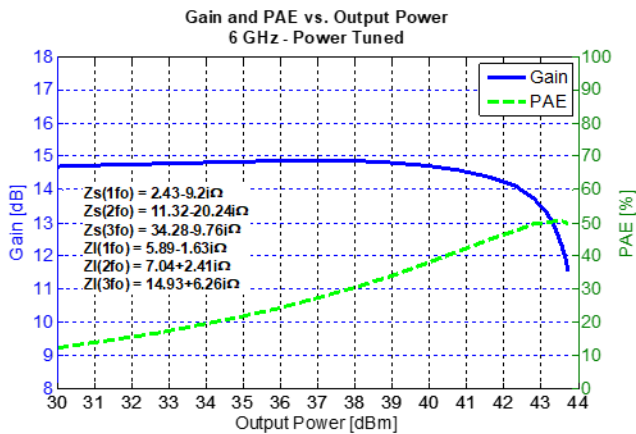
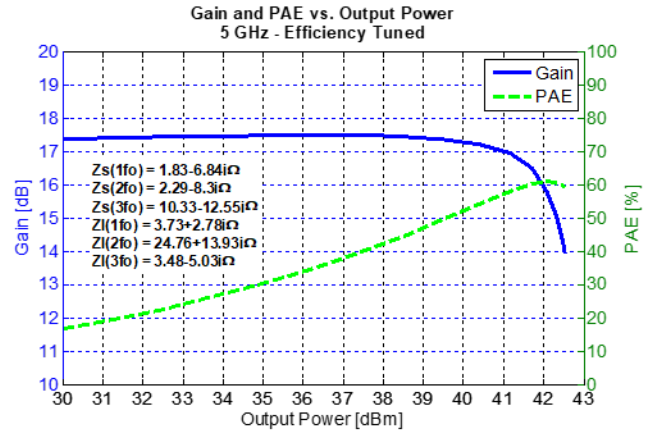
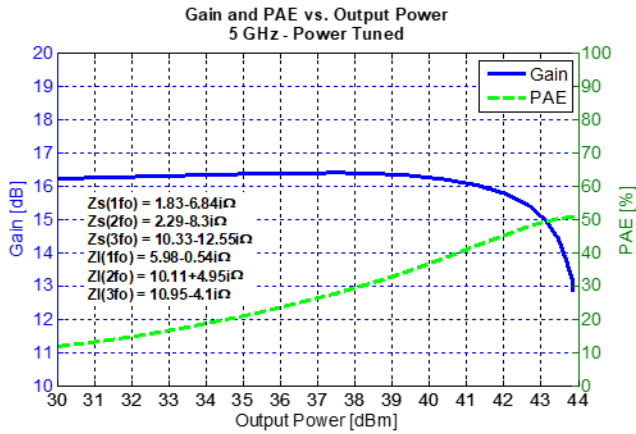

Typical Measured Performance – Load-Pull Drive-up

Test Conditions:  $V_D = +32\text{ V}$ ,  $I_{DQ} = 25\text{ mA}$ ,  $T = +25^\circ\text{C}$ , Pulse (10% Duty Cycle, 100  $\mu\text{s}$  Width).

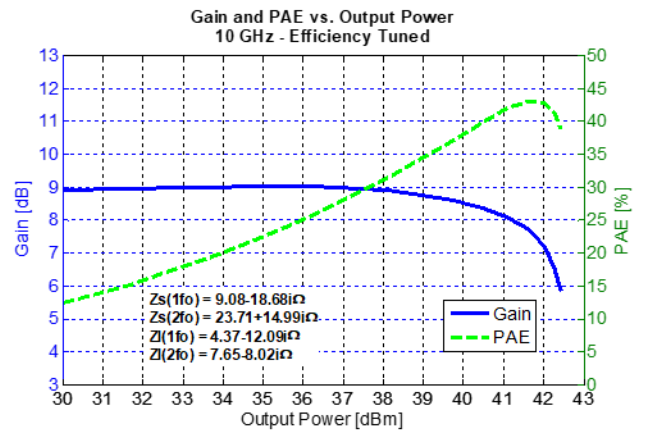
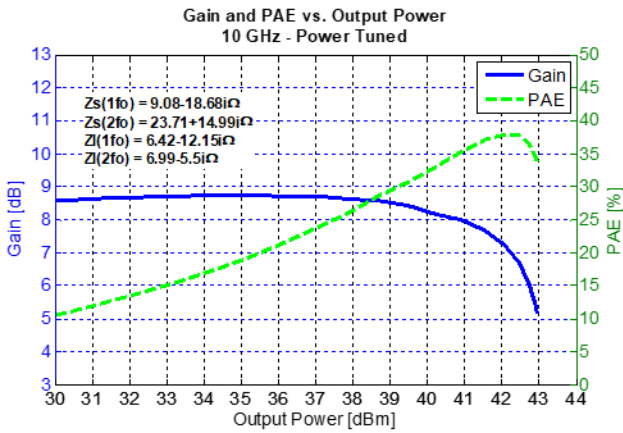
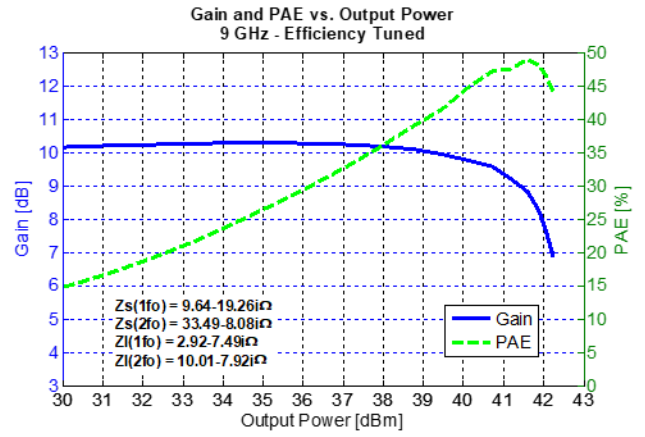
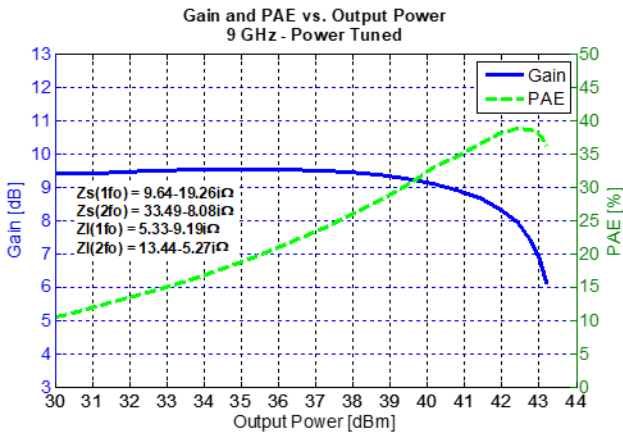

## S-Parameters Of 9 – 10 GHz EVB

Test Conditions:  $V_D = +32\text{ V}$ ,  $I_{DQ} = 140\text{ mA}$ ,  $T = +25^\circ\text{C}$

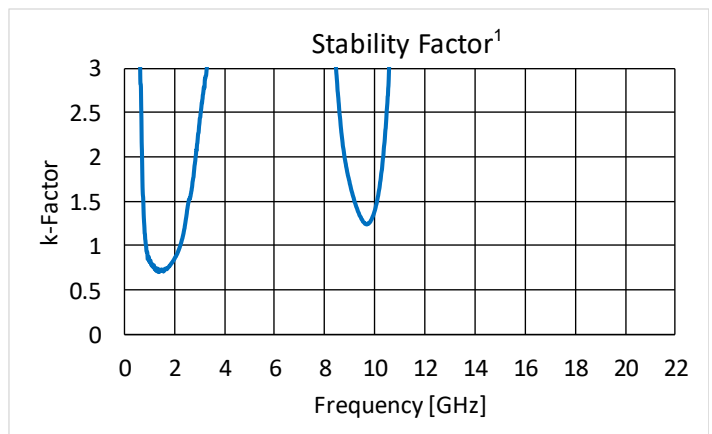
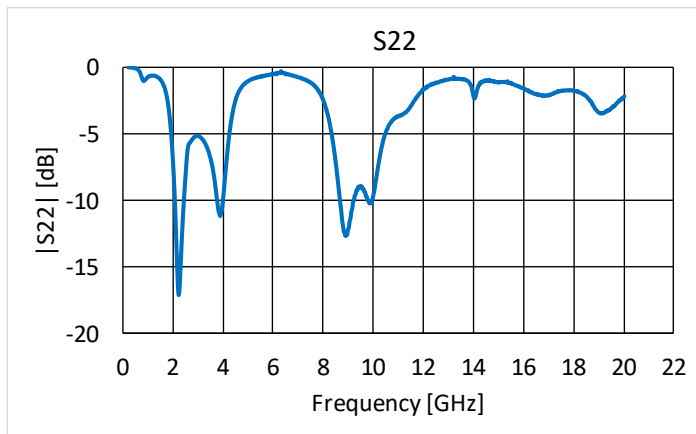
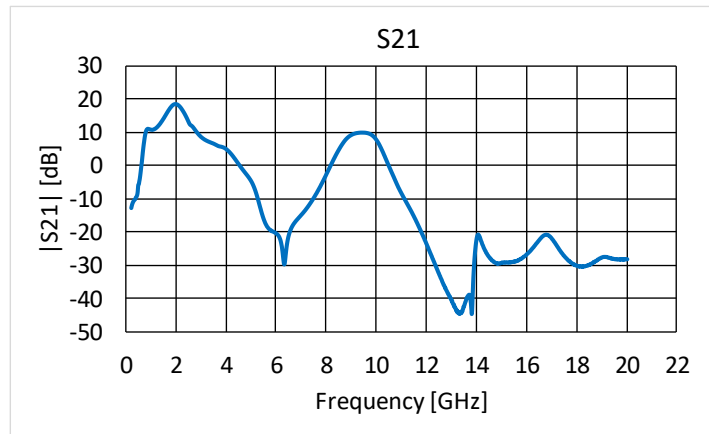
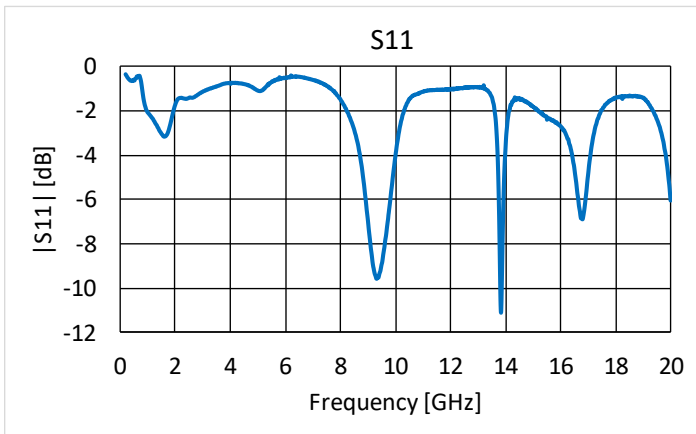

Notes:

1. The EVB is stable at  $-40^\circ\text{C}$  and 10:1 VSWR at the output.

Power Driveup Performance Over Temperatures Of 9 – 10 GHz EVB

Test Conditions:  $V_D = +32\text{ V}$ ,  $I_{DQ} = 140\text{ mA}$ ,  $T = +25^\circ\text{C}$ , Pulse (20% Duty Cycle, 100  $\mu\text{s}$  Width).

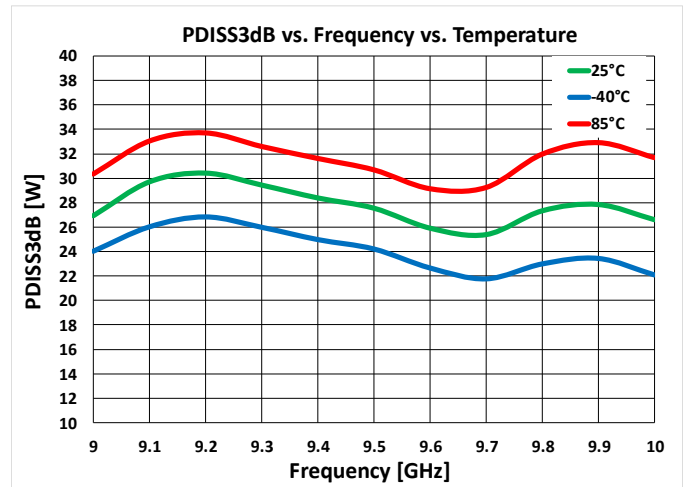
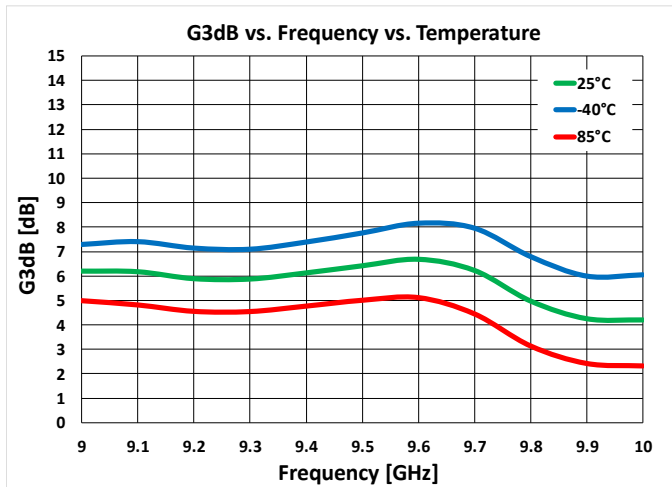
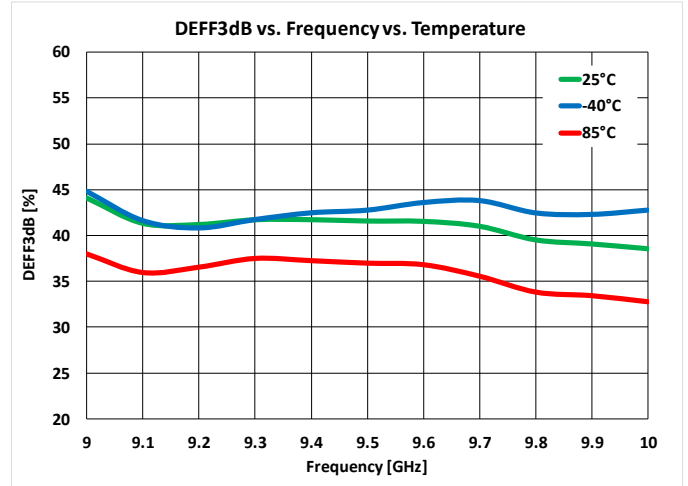
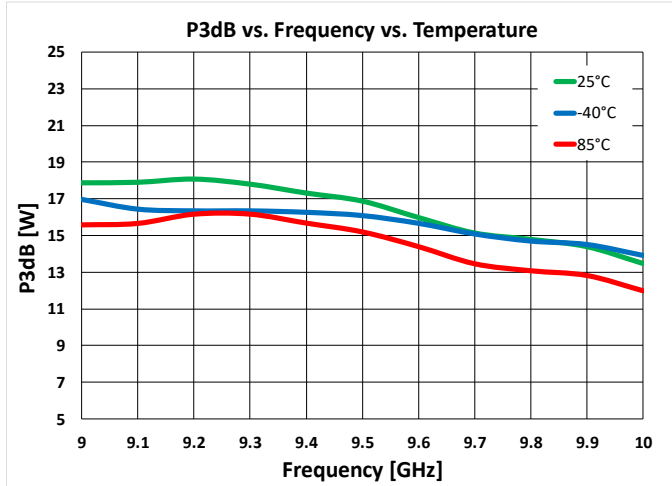

Notes:

1. The dissipation power limit is conservative because it is specified at DUT only without accounting for the loss of the output matching network.

## Power Driveup Performance Of 9 – 10 GHz EVB

Test Conditions:  $V_D = +32\text{ V}$ ,  $I_{DQ} = 140\text{ mA}$ ,  $T = +25^\circ\text{C}$ , Pulse (20% Duty Cycle, 100  $\mu\text{s}$  Width).

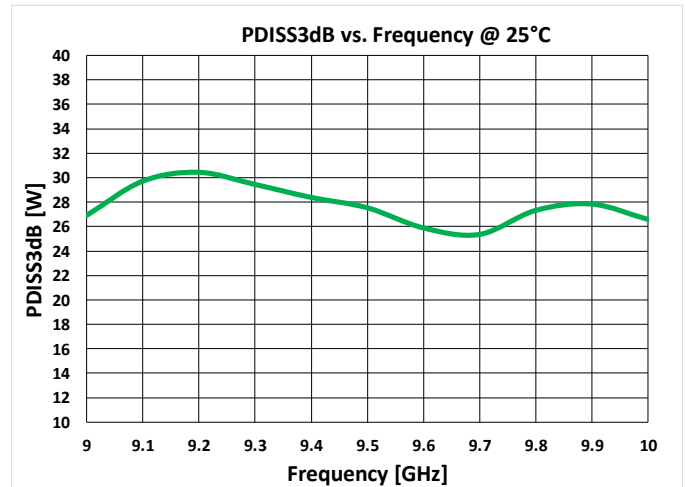
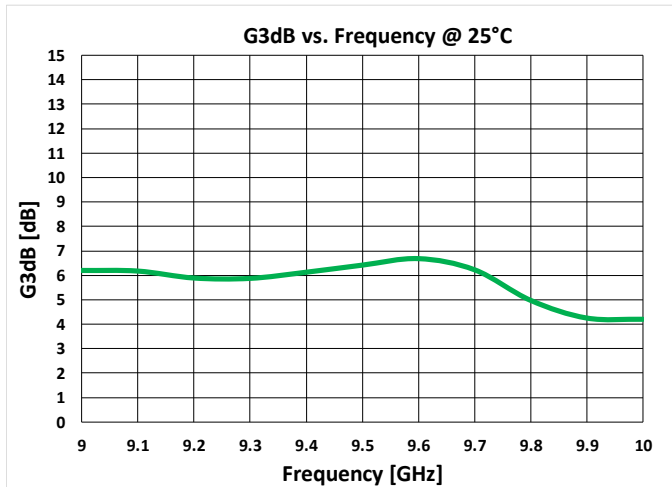
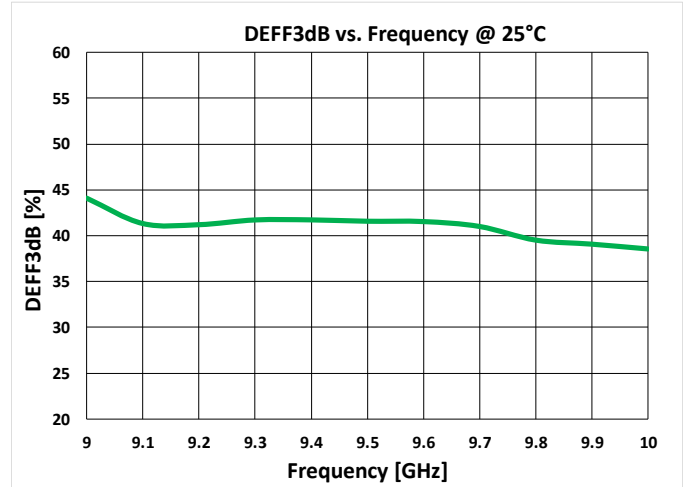
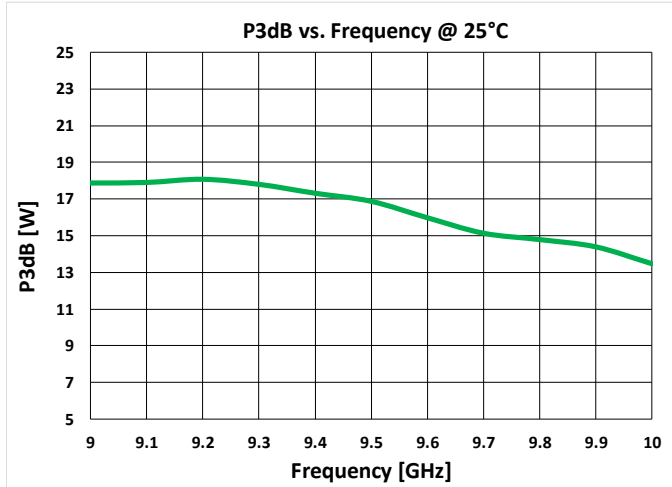

Notes:

1. The dissipation power is conservative because it is specified at DUT only without accounting for the loss of the output matching network.

### S-Parameters Of 2.7 – 3.3 GHz EVB

Test Conditions:  $V_D = +32\text{ V}$ ,  $I_{DQ} = 100\text{ mA}$ ,  $T = +25^\circ\text{C}$

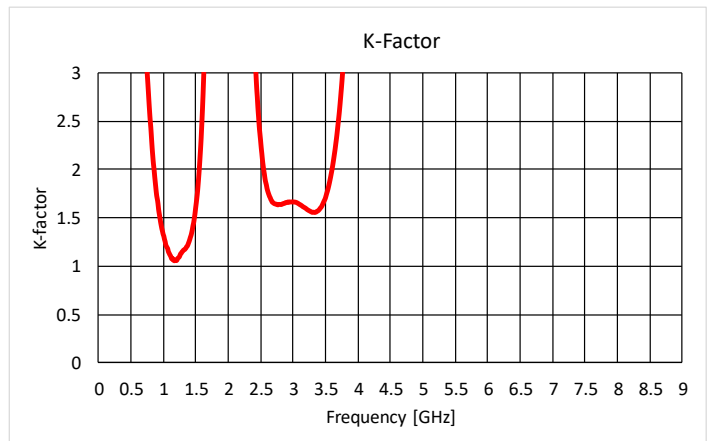
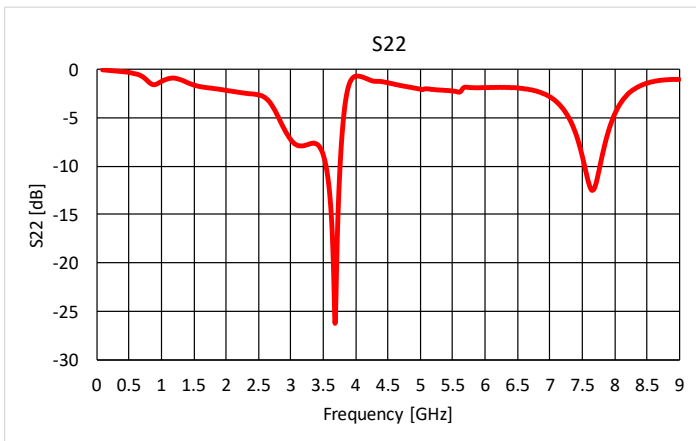
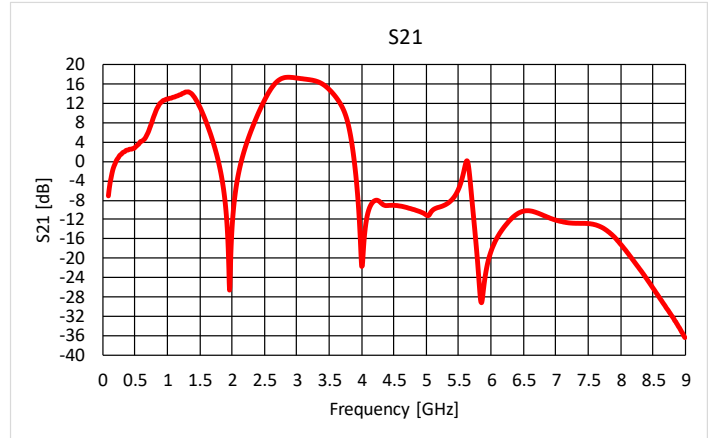
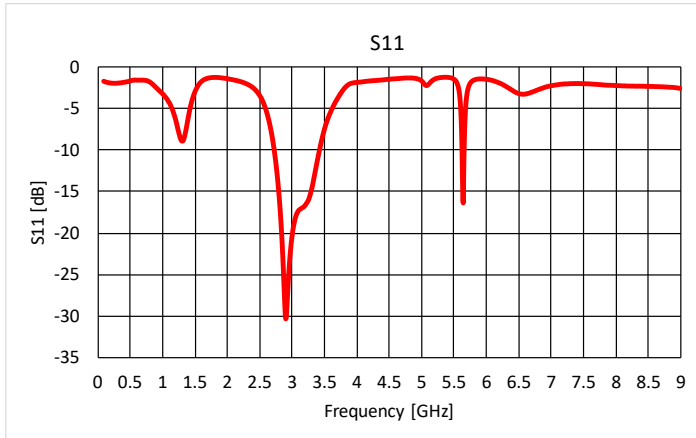



## Power Driveup Performance Of 2.7 – 3.3 GHz EVB

Test Conditions:  $V_D = +32\text{ V}$ ,  $I_{DQ} = 100\text{ mA}$ ,  $T = +25^\circ\text{C}$ , Pulse (20% Duty Cycle, 100  $\mu\text{s}$  Width).

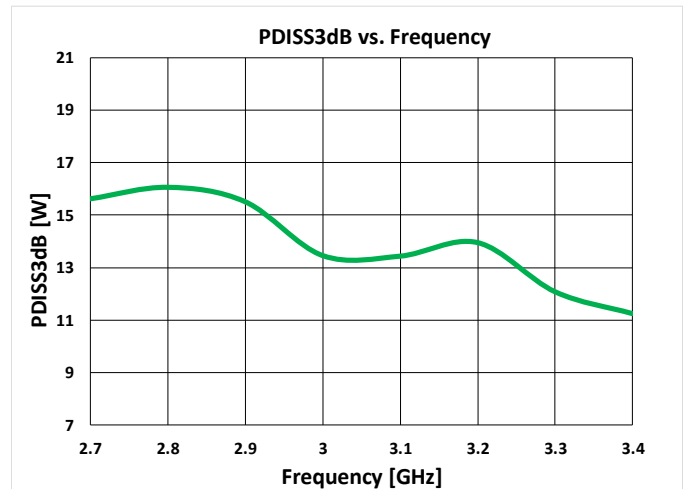
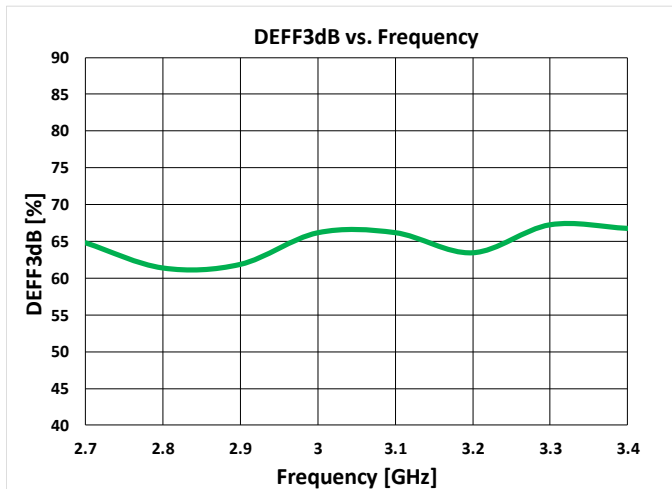
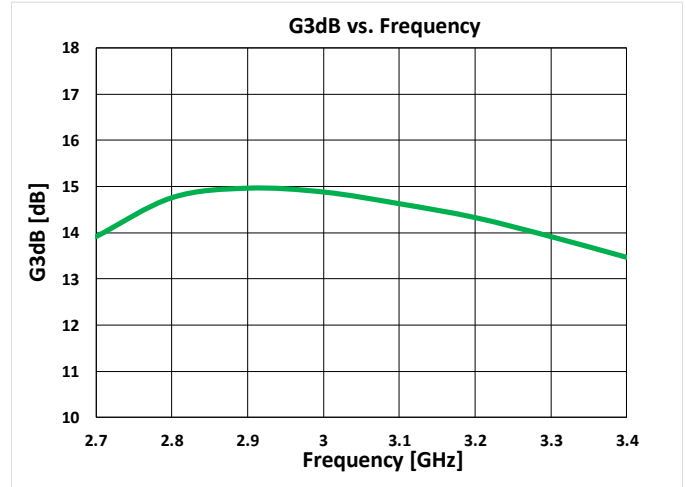
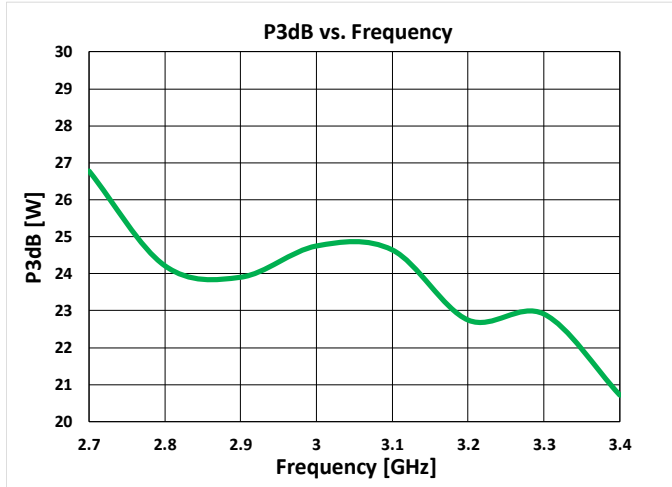

Notes:

1. The dissipation power is conservative because it is specified at DUT only without accounting for the loss of the output matching network.

**S-Parameters Of 3.1 – 3.5 GHz EVB**

Test Conditions:  $V_D = +32\text{ V}$ ,  $I_{DQ} = 100\text{ mA}$ ,  $T = +25^\circ\text{C}$

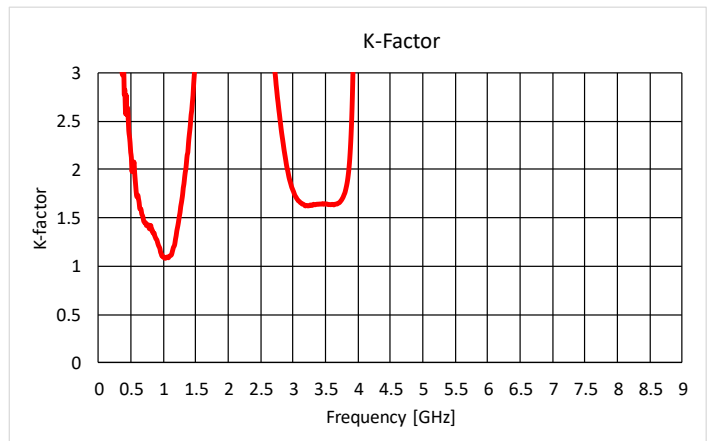
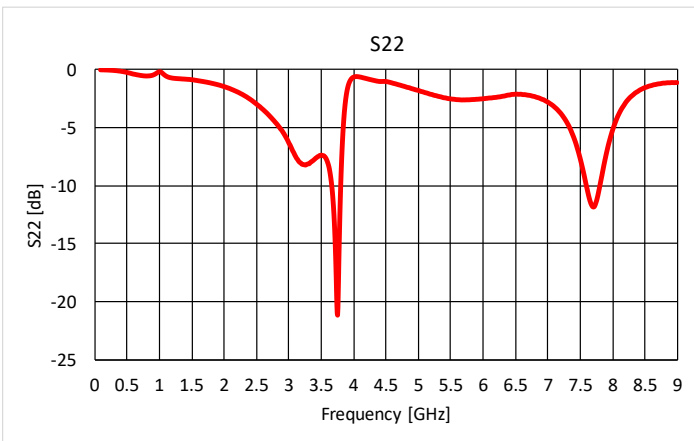
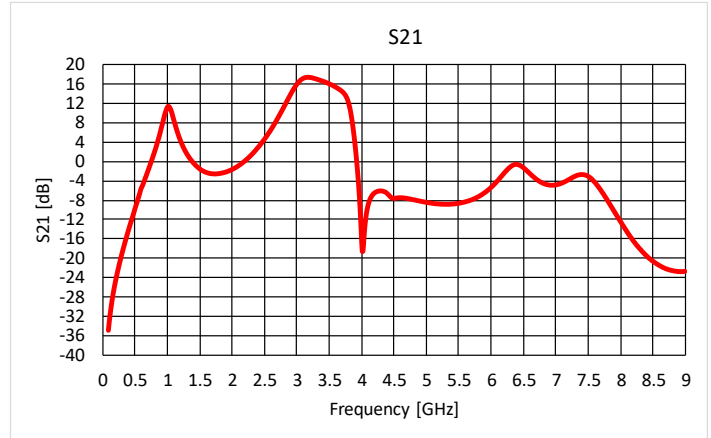
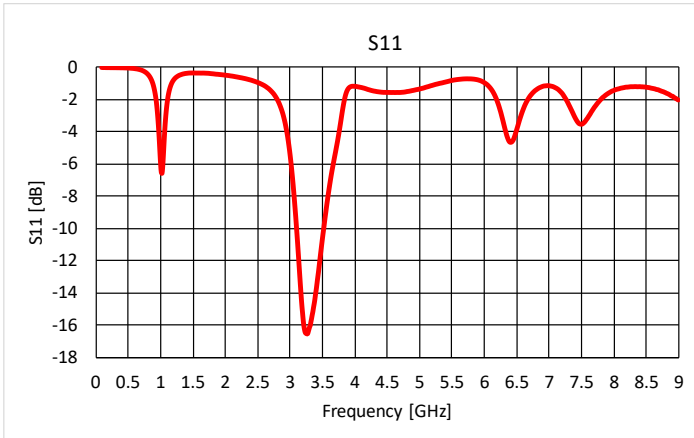

## Power Driveup Performance Of 3.1 – 3.5 GHz EVB

Test Conditions:  $V_D = +32\text{ V}$ ,  $I_{DQ} = 100\text{ mA}$ ,  $T = +25^\circ\text{C}$ , Pulse (20% Duty Cycle, 100  $\mu\text{s}$  Width).

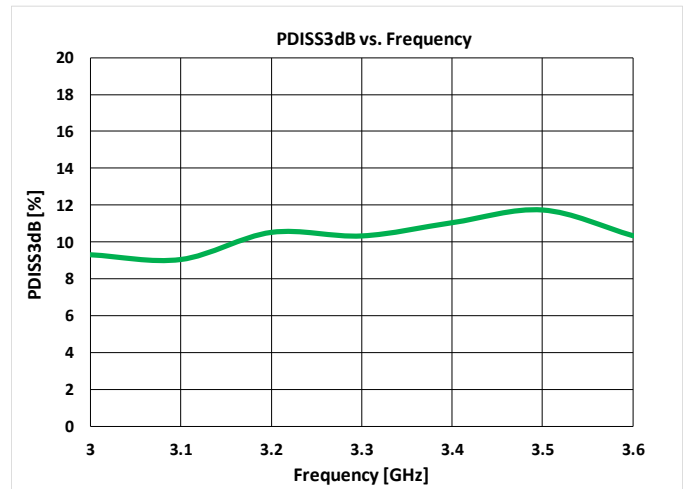
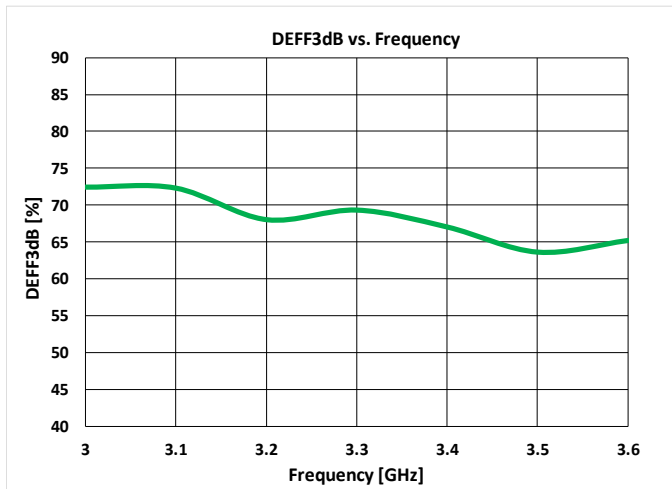
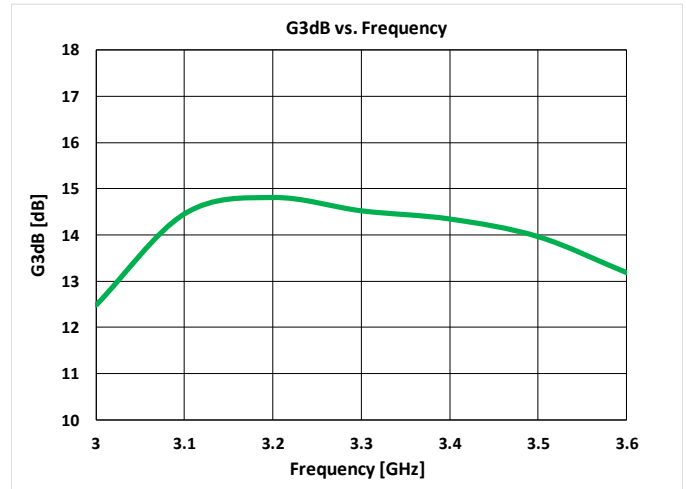
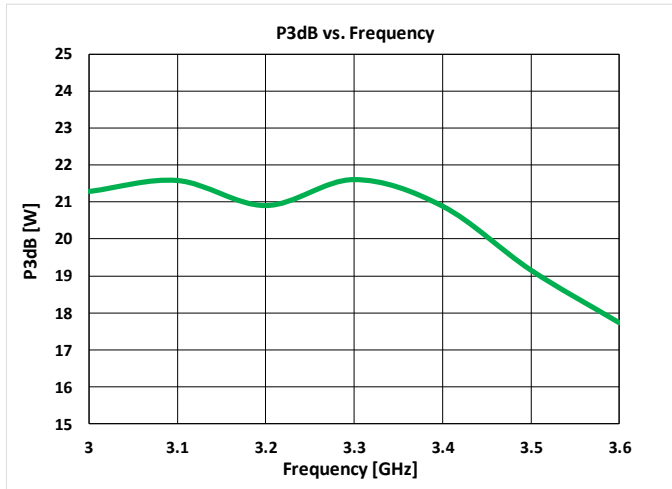

Notes:

1. The dissipation power is conservative because it is specified at DUT only without accounting for the loss of the output matching network.

## S-Parameters Of 4 – 5 GHz EVB

Test Conditions:  $V_D = +32\text{ V}$ ,  $I_{DQ} = 100\text{ mA}$ ,  $T = +25^\circ\text{C}$

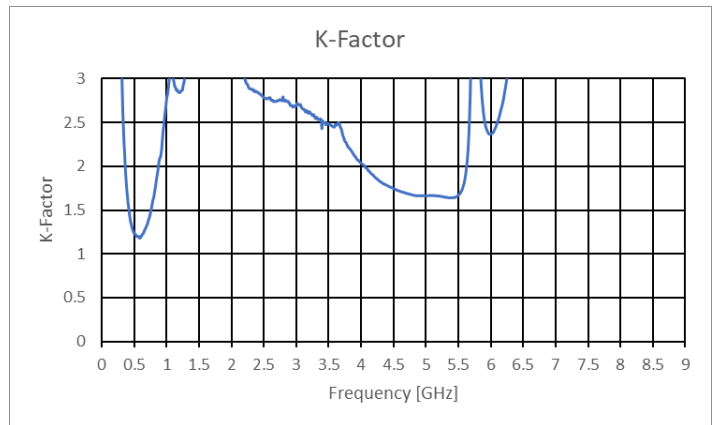
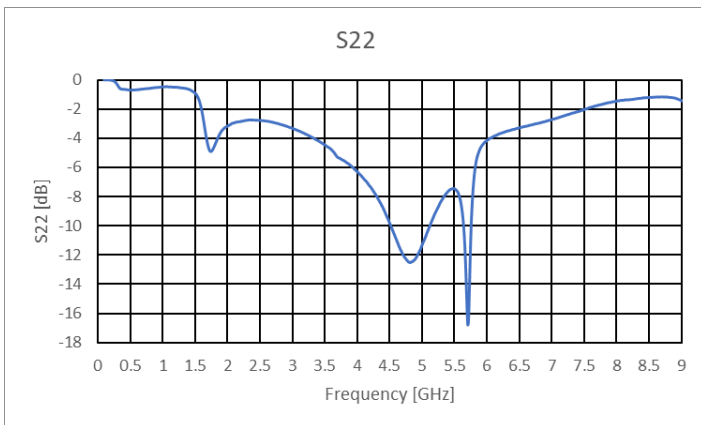
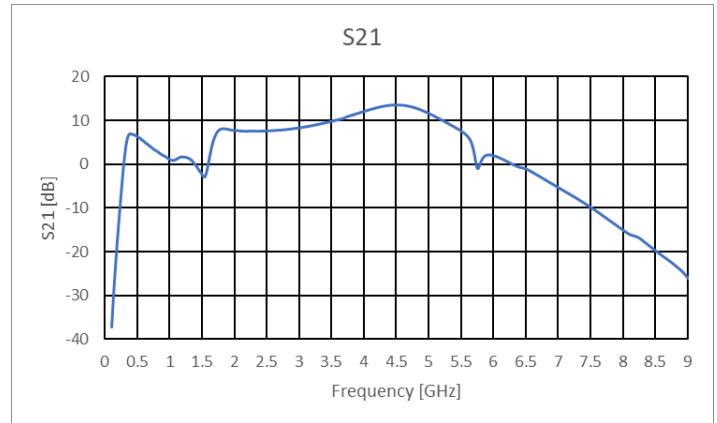
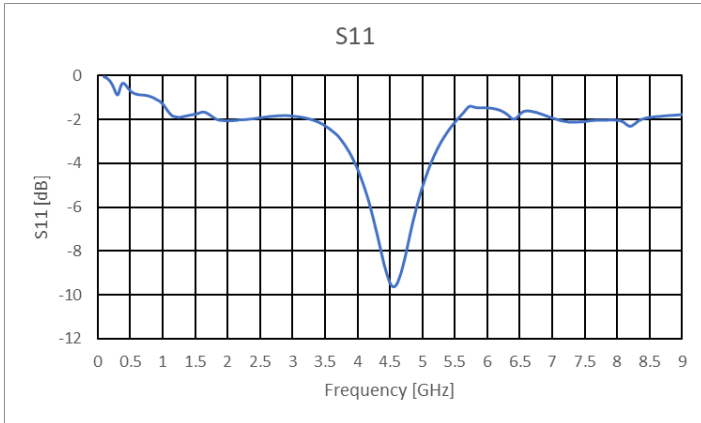

## Power Driveup Performance Of 4 – 5 GHz EVB

Test Conditions:  $V_D = +32\text{ V}$ ,  $I_{DQ} = 100\text{ mA}$ ,  $T = +25^\circ\text{C}$ , Pulse (20% Duty Cycle, 100  $\mu\text{s}$  Width).

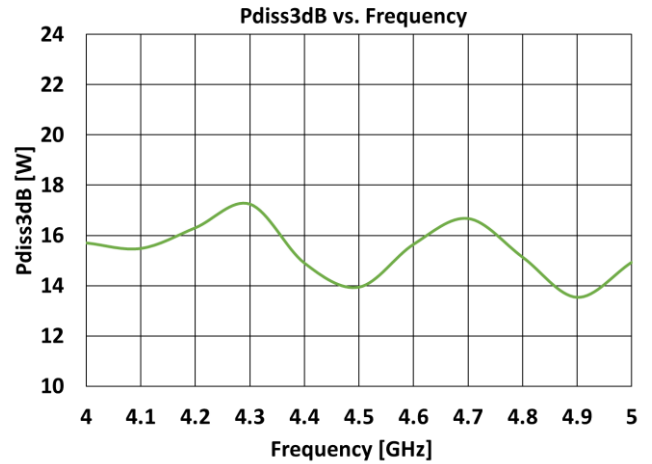
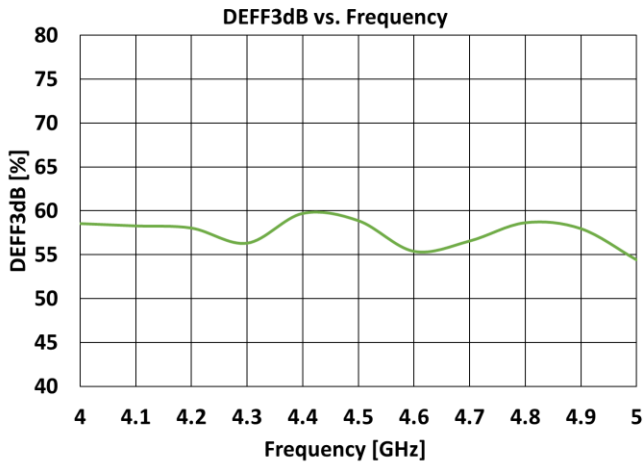
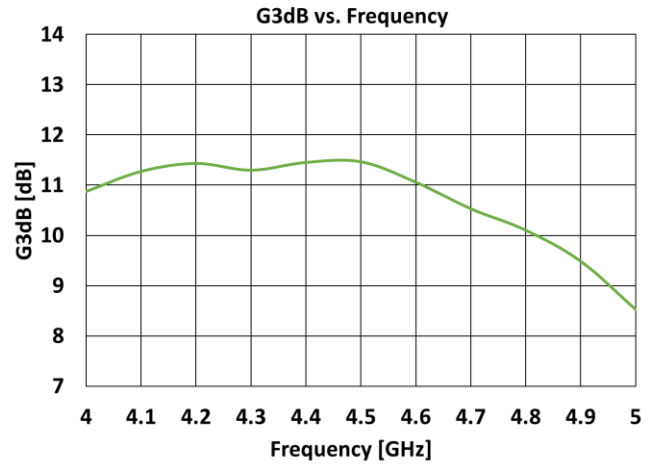
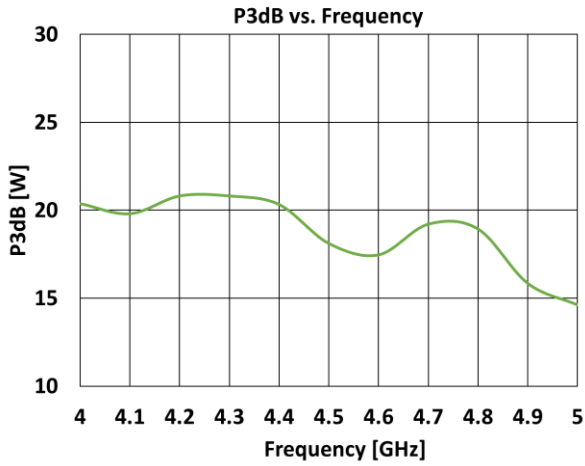

Notes:

1. The dissipation power is conservative because it is specified at DUT only without accounting for the loss of the output matching network.

S-Parameters Of 5 – 6 GHz EVB

Test Conditions:  $V_D = +32\text{ V}$ ,  $I_{DQ} = 100\text{ mA}$ ,  $T = +25^\circ\text{C}$

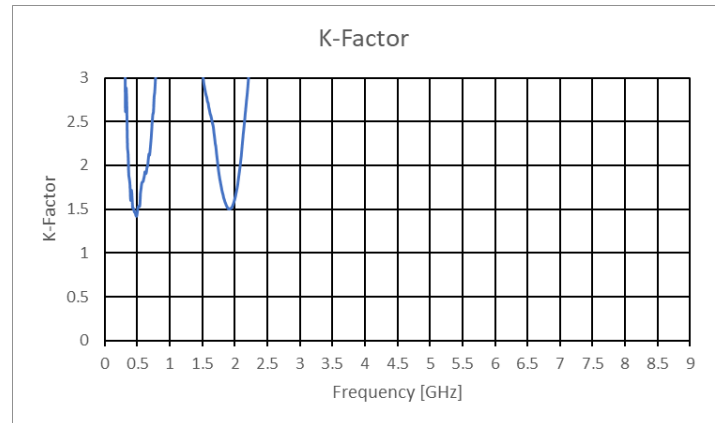
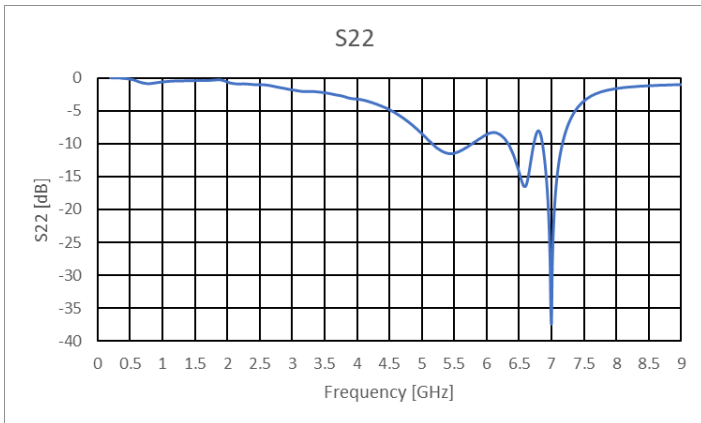
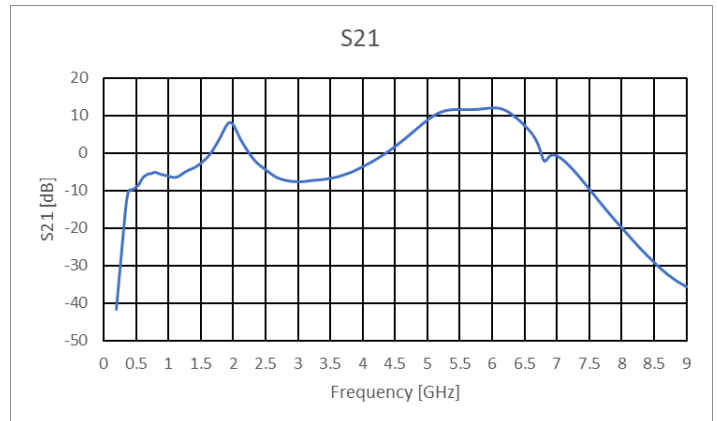
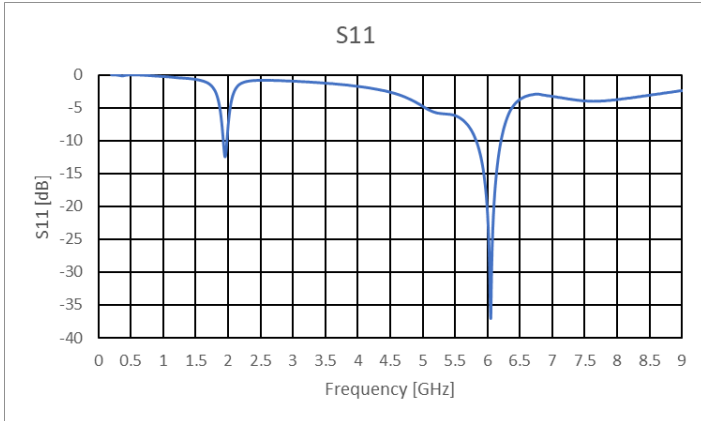

## Power Driveup Performance Of 5 – 6 GHz EVB

Test Conditions:  $V_D = +32\text{ V}$ ,  $I_{DQ} = 100\text{ mA}$ ,  $T = +25^\circ\text{C}$ , Pulse (20% Duty Cycle, 100  $\mu\text{s}$  Width).

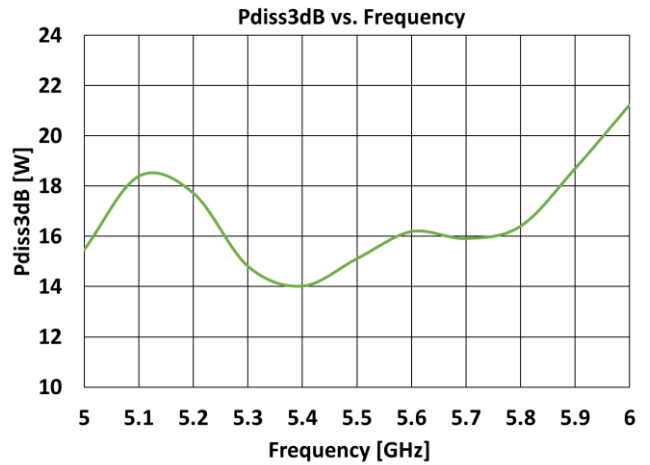
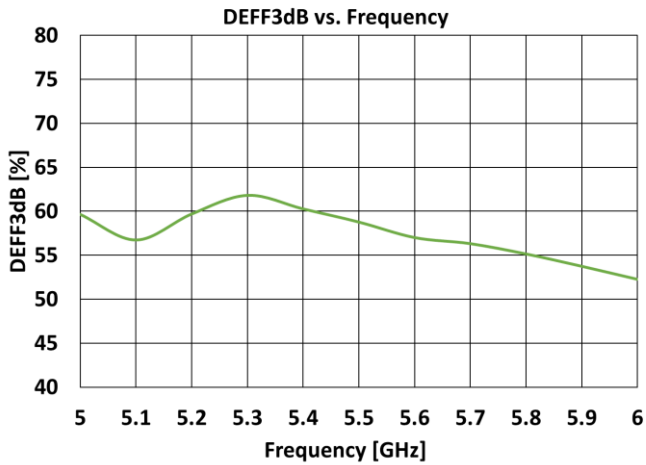
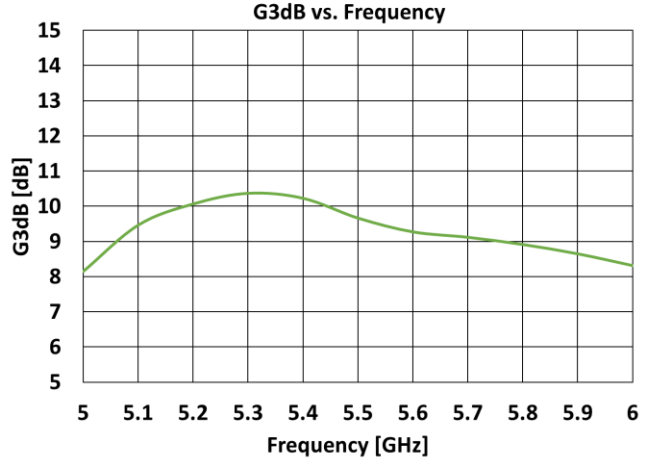
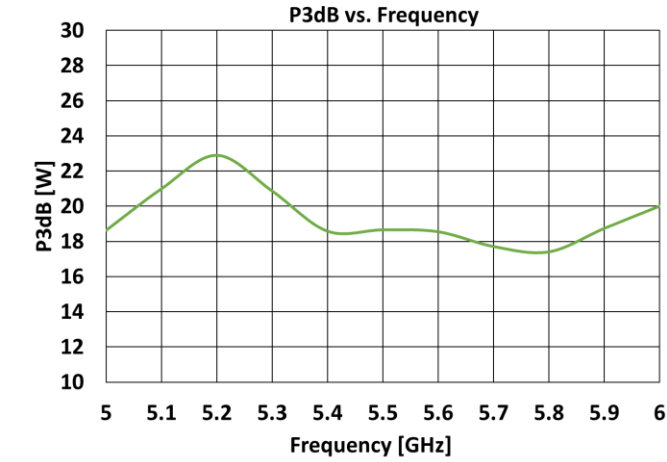

Notes:

1. The dissipation power is conservative because it is specified at DUT only without accounting for the loss of the output matching network.

## 9 – 10 GHz Application Circuit - Schematic

Board material is RO4003C 0.008" thickness with 1oz copper cladding. Overall EVB size is 1.5" x 2".

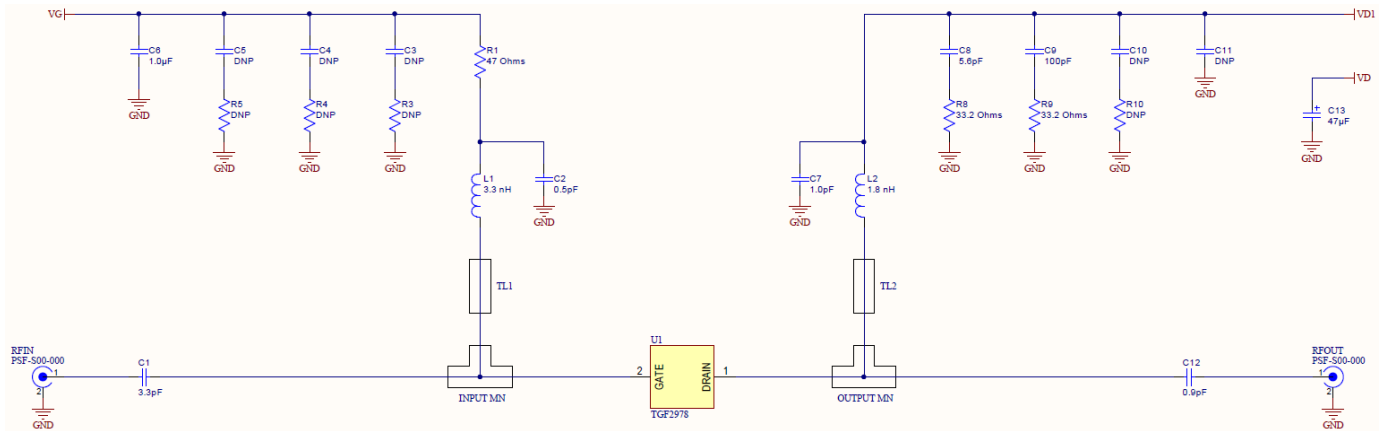
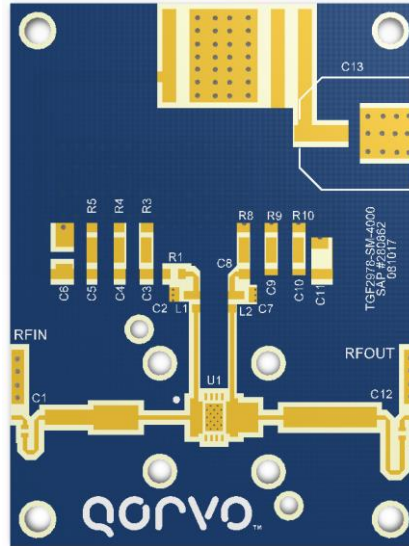

## 9 – 10 GHz Application Circuit - Bill Of material

Description	Ref. Des.	Manufacturer	Part Number
Capacitor 3.3 pF, 200V, 0402	C1	AVX Corporation	UQCL2A3R3BAT2A\500
Capacitor 0.5 pF, 250V, 0603	C2	Johanson Technology	251R14S0R5AV4T
Capacitor 1.0 uF, 50V, 0805	C6	American Technical Ceramics	C0805C105K5RACTU
Capacitor 2.2 pF, 250V, 0603	C7	American Technical Ceramics	600S1R0AT250XT
Capacitor 5.6 pF, 250V, 0603	C8	American Technical Ceramics	600S5R6BW250XT
Capacitor 100 pF, 250V, 0603	C9	American Technical Ceramics	600S101JT250XT
Capacitor 0.9 pF, 200V, 0402	C12	American Technical Ceramics	600L0R9AT200T
Capacitor 220 uF, 50V, 10 mm	C16	Panasonic Industrial Devices	EEEFK1H221P
Resistor, 47 Ohm, 0603	R1	Rohm Electronics	KTR03EZPF47R0
Resistor, 33.2 Ohm, 0603	R8, R9	Vishay Americas Inc	CRCW060333R2FKTA
Inductor 3.3 nH, 0402	L1	Murata Electronics	LQW15AN3N3B80D
Inductor 1.8 nH, 0402	L2	Coilcraft, Inc.	0402CS-1N8XJEW



## 2.7 – 3.3 GHz Application Circuit - Schematic

Board material is RO4350B 0.020" thickness with 1oz copper cladding. Overall EVB size is 2.5" x 2".

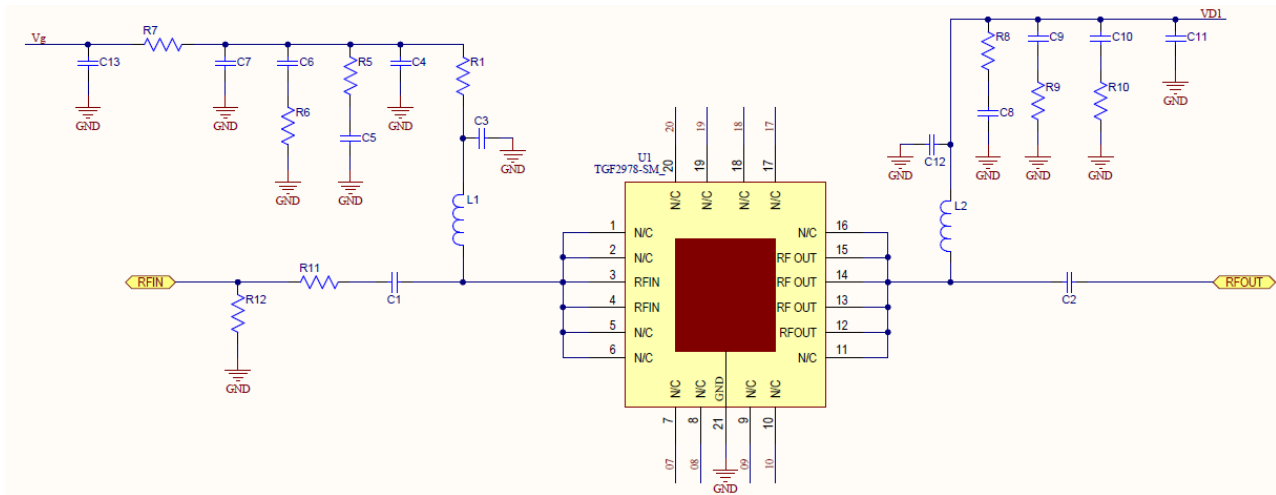
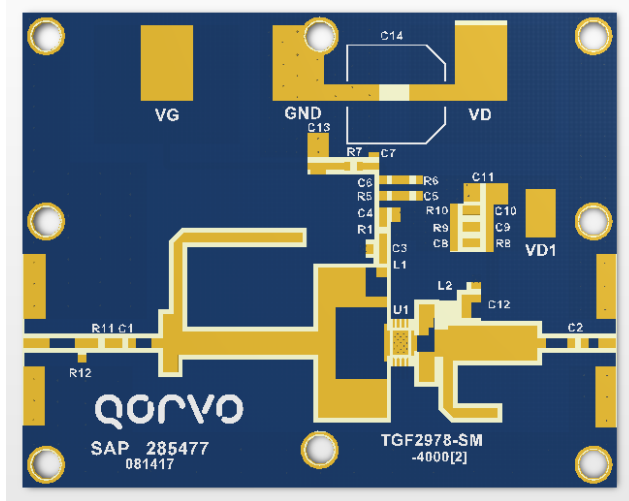

## 2.7 – 3.3 GHz Application Circuit - Bill Of material

Description	Ref. Des.	Manufacturer	Part Number
Capacitor 10 pF, 250V, 0603	C1	American Technical Ceramics	600S100JT250XT
Capacitor 1.5 pF, 250V, 0603	C2	American Technical Ceramics	600S1R5AT250X
Capacitor 2.2 pF, 250V, 0603	C4, C12	American Technical Ceramics	600S2R2BT250T
Capacitor 100 pF, 200V, 0603	C5, C8	Capax Technologies	0603G101J201S
Capacitor 0.01 uF, 50V, 0603	C6, C9	Kemet	C0603C103K5RACTU
Capacitor 1 uF, 50V, 1206	C11, C13	TDK Singapore (PTE) LTD	C3216X7R1H105K160AB
Capacitor 47 uF, 80V, 10 mm	C14	Panasonic Industrial Devices	EEETG1K470UP
Resistor, 47 Ohm, 0603	R1	Rohm Electronics	KTR03EZPF47R0
Resistor, 33.2 Ohm, 0603	R5, R6, R8	Vishay Americas Inc	CRCW060333R2FKTA
Resistor, 0 Ohm, 0603	R7	Vishay Americas Inc	CRCW06030000Z0EA
Inductor 5.6 nH, 0603	L1	Coilcraft, Inc.	0603CS-5N6XJEW
Inductor 5.6 nH, 1606	L2	Coilcraft, Inc.	1606-6GLC

### 3.1 – 3.5 GHz Application Circuit - Schematic

Board material is RO4350B 0.020" thickness with 1oz copper cladding. Overall EVB size is 2.5" x 2".

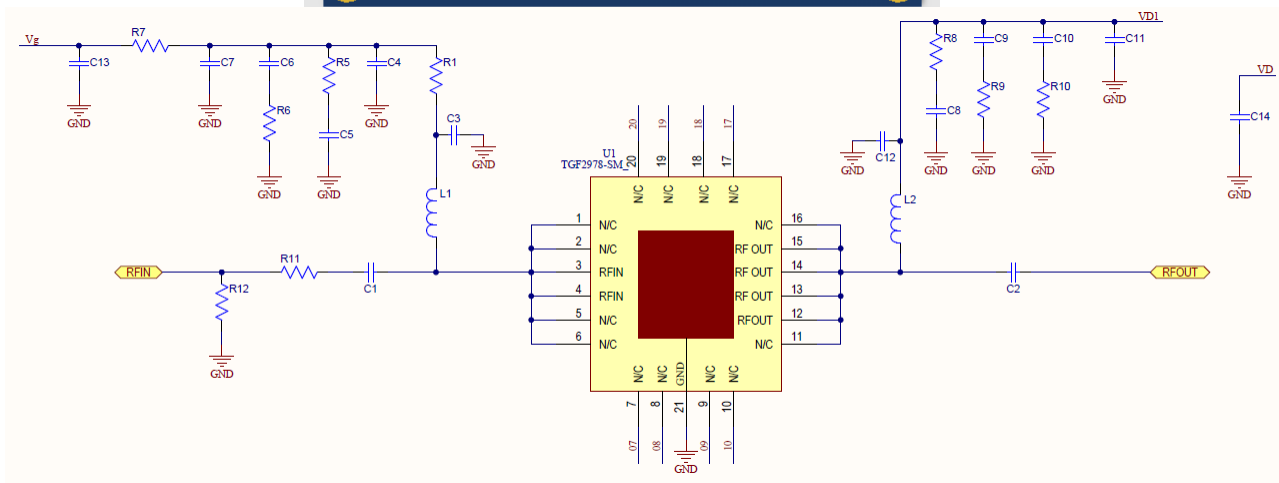
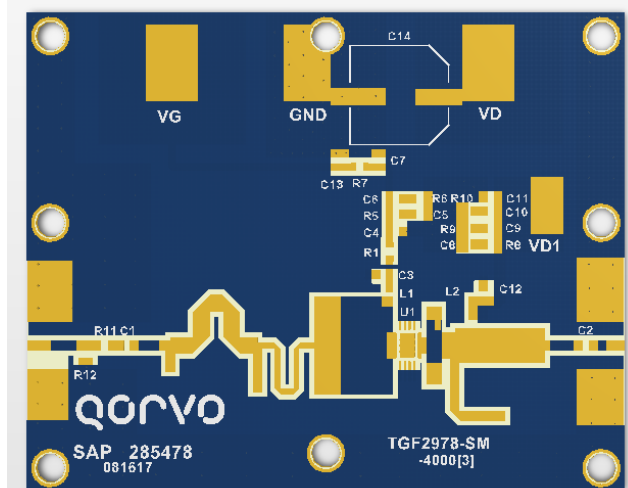

### 3.1 – 3.5 GHz Application Circuit - Bill Of material

Description	Ref. Des.	Manufacturer	Part Number
Capacitor 0.7 pF, 250V, 0603	C1	American Technical Ceramics	600S0R7AT250XT
Capacitor 1 pF, 250V, 0603	C2	American Technical Ceramics	600S1R0AT250XT
Capacitor 2.2 pF, 250V, 0603	C3	American Technical Ceramics	600S2R2BT250T
Capacitor 100 pF, 200V, 0603	C4, C9	Capax Technologies	0603G101J201S
Capacitor 0.01 uF, 50V, 0603	C5, C10	Kemet	C0603C103K5RACTU
Capacitor 0.1 uF, 50V, 0603	C6, C11	Kemet	C0603C104J5RACTU
Capacitor 1 uF, 50V, 10 mm	C13	Taiyo Yuden PTE LTD	UMK107AB7105KA
Capacitor 100 uF, 80V, 8 mm	C14	Panasonic Industrial Devices	EEE-1HA101UAP
Resistor, 0 Ohm, 0603	R1	Vishay Americas Inc	CRCW06030000Z0EA
Resistor, 50 Ohm, 0603	R2, R3, R4, R5, R6, R7, R8	Vishay Americas Inc	CRCW06030000Z0EA
Inductor 5.6 nH, 0603	L1	Coilcraft, Inc.	0603CS-5N6XJEW
Inductor 5.6 nH, 1606	L2	Coilcraft, Inc.	1606-6GLC

### 4 – 5 GHz Application Circuit - Schematic

Board material is RO4350B 0.020" thickness with 1oz copper cladding. Overall EVB size is 1.5" x 2".

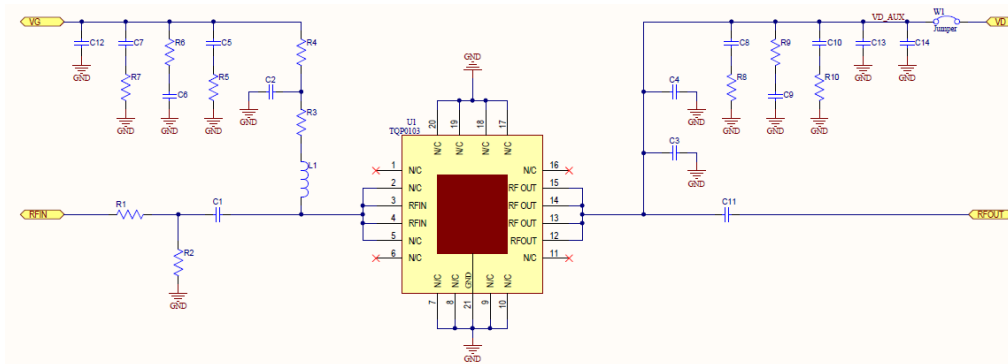
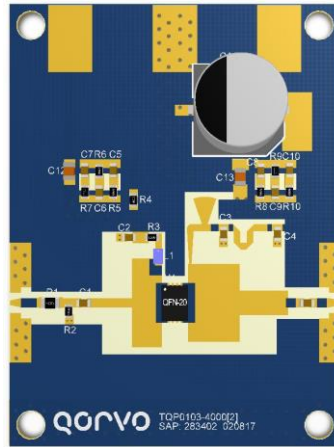

### 4 – 5 GHz Application Circuit - Bill Of material

Description	Ref. Des.	Manufacturer	Part Number
Capacitor 2.4 pF, 250V, 0603	C1	American Technical Ceramics	600S2R4AT250XT
Capacitor 5.6 pF, 250V, 0603	C2	American Technical Ceramics	600S5R6BT250XT
Capacitor 2.2 pF, 250V, 0603	C3	American Technical Ceramics	600S2R2BT250T
Capacitor 0.5 pF, 250V, 0603	C4	Johanson	251R14S0R5AV4T
Capacitor 100 pF, 250V, 0603	C5, C8	American Technical Ceramics	600S101JT250XT
Capacitor 0.1 uF, 50V, 0603	C7	Kemet	C0603C104J5RACTU
Capacitor 1.6 pF, 250V, 0603	C11	American Technical Ceramics	600S1R6BT250XT
Capacitor 1.0 uF, 100V, 0805	C12, C13	TDK Singapore (PTE) LTD	C2012X7S2A105M125AB
Capacitor 33 uF, 80V, 10 mm	C14	Panasonic Industrial Devices	EEE-FK1K330P
Resistor, 2.7 Ohm, 0603	R1	Panasonic Industrial Devices	ERJ-6RQF2R7V
Resistor, 820 Ohm, 0603	R2	KOA Speer Electronics, Inc.	RK73B1JTDD821J
Resistor, 22 Ohm, 0603	R3	Panasonic Industrial Devices	ERJ3GEYJ220V
Resistor, 0 Ohm, 0603	R4	Kamaya, Inc	RMC1/16JPTP
Resistor, 33 Ohm, 0603	R5	KOA Speer Electronics, Inc.	RK73B1JTDD330J
Inductor 3.9 nH, 0603	L1	Coilcraft, Inc.	0603HC-3N9XJRW

## 5 – 6 GHz Application Circuit - Schematic

Board material is RO4003C 0.008" thickness with 1oz copper cladding. Overall EVB size is 1" x 1".

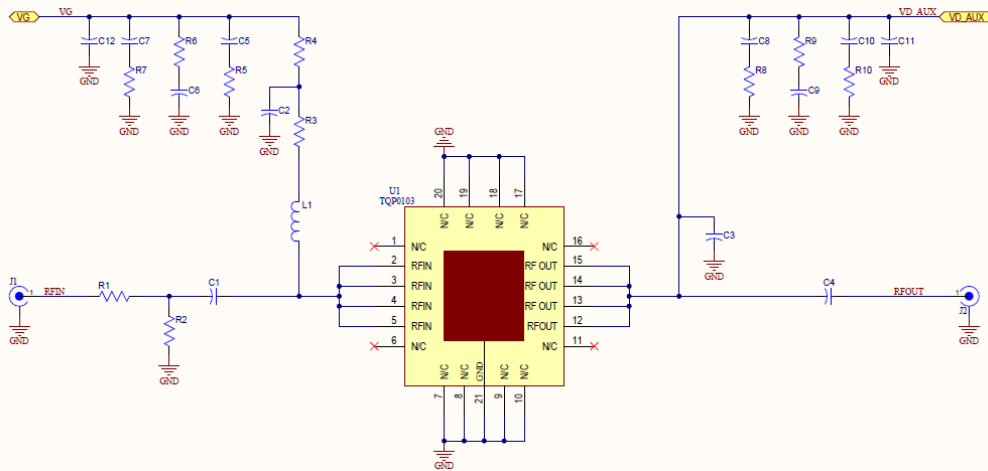
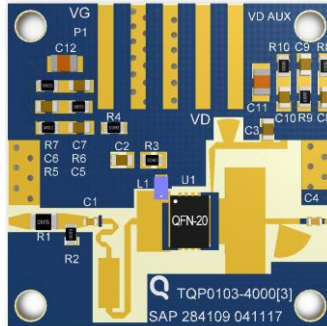

## 5 – 6 GHz Application Circuit - Bill Of material

Description	Ref. Des.	Manufacturer	Part Number
Capacitor 0.5 pF, 200V, 0402	C1	American Technical Ceramics	600L0R5AT200T
Capacitor 5.6 pF, 250V, 0603	C2	American Technical Ceramics	600S5R6BT250XT
Capacitor 1.2 pF, 250V, 0603	C3	American Technical Ceramics	600S1R2BT250XT
Capacitor 1.2 pF, 200V, 0402	C4	AVX Corporation	UQCL2A1R2BAT2A\500
Capacitor 100 pF, 250V, 0603	C5, C10	American Technical Ceramics	600S101JT250XT
Capacitor 0.01 uF, 50V, 0603	C6, C9	Kemet	C0603T103K5RALT M
Capacitor 0.1 uF, 50V, 10 mm	C7	Kemet	C0603C104J5RACTU
Resistor, 2.7 Ohm, 0805	R1	Panasonic Industrial Devices	ERJ-6RQF2R7V
Resistor, 820 Ohm, 0603	R2	KOA Speer Electronics, Inc.	RK73B1JT TD821J
Resistor, 10 Ohm, 0603	R3	KOA Speer Electronics, Inc.	RK73B1JT TD100J
Resistor, 820 Ohm, 0603	R2	KOA Speer Electronics, Inc.	RK73B1JT TD821J
Resistor, 0 Ohm, 0603	R4	Kamaya, Inc	RMC1/16JPTP
Resistor, 33 Ohm, 0603	R5, R6, R7, R9, R10	KOA Speer Electronics, Inc.	RK73B1JT TD330J
Inductor 8.2 nH, 0603	L1	Murata Electronics	LQP18MN8N2C02D

Mechanical Drawing<sup>1, 2, 3</sup>

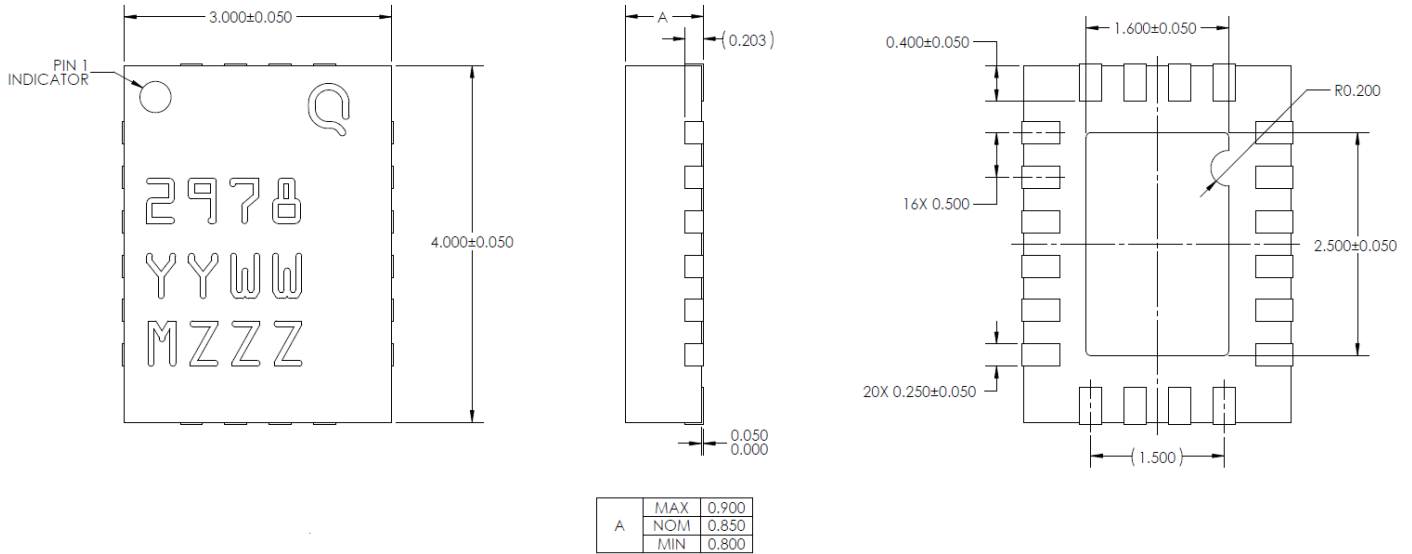

Note:

1. All dimensions are in millimeters.
2. Unless otherwise noted, all dimension tolerances are  $\pm 0.127$  mm.
3. This package is lead-free/RoHS-compliant. The plating material on the leads is NiPdAu. It is compatible with both lead-free (maximum 260°C reflow temperature) and tin-lead (maximum 245°C reflow temperature) soldering process.

## Pin Configuration and Description<sup>1</sup>

Note 1: The TGF2978-SM will be marked with the “2978” designator and a lot code marked below the part designator. The “YY” represents the last two digits of the calendar year the part was manufactured, the “WW” is the work week of the assembly lot start, the MZZZ” is the production lot number.

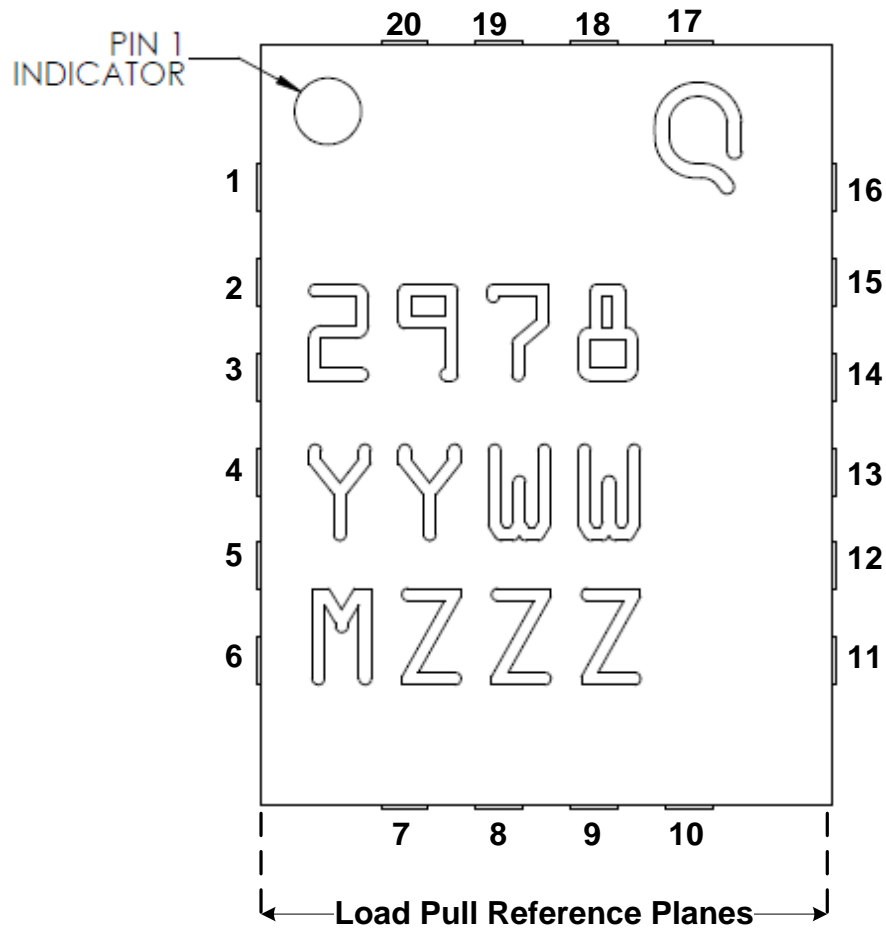

Pin	Symbol	Description
12 - 15	$V_D$ / RF OUT	Drain voltage / RF Output to be matched to 50 ohms; see EVB Layout on page 19 as an example.
3 - 4	$V_G$ / RF IN	Gate voltage / RF Input to be matched to 50 ohms; see EVB Layout on page 19 as an example.
1 - 2, 5 - 11, 16 - 20	N/C	Not connected
Back side	Source	Source connected to ground

## Model

---

A model is available for download from Modelithics (at <http://www.modelithics.com/mvp/Qorvo&tab=3>) by approved Qorvo customers. The model is compatible with the industry's most popular design software including Agilent ADS and National Instruments/AWR applications. Once on the Modelithics web page, the user will need to register for a free license before being granted the download.

## Assembly Notes

---

Component placement and adhesive attachment assembly notes:

- Vacuum pencils and/or vacuum collets are the preferred method of pick up.
- Air bridges must be avoided during placement.
- The force impact is critical during auto placement.
- Organic attachment (i.e. epoxy) not recommended.

Reflow process assembly notes:

- Use AuSn (80/20) solder and limit exposure to temperatures above 300°C to 3-4 minutes, maximum.
- An alloy station or conveyor furnace with reducing atmosphere should be used.
- Do not use any kind of flux.
- Coefficient of thermal expansion matching is critical for long-term reliability.
- Devices must be stored in a dry nitrogen atmosphere.

Interconnect process assembly notes:

- Ball bonding is the preferred interconnect technique, except where noted on the assembly diagram.
- Force, time, and ultrasonics are critical bonding parameters.
- Aluminum wire should not be used.
- Devices with small pad sizes should be bonded with 0.0007-inch wire.

## Disclaimer

---

GaN/SiC devices are susceptible to damage from Electrostatic Discharge. Proper precautions should be observed during handling, assembly and test.

## Bias Procedure

---

<b>Bias-Up Procedure</b>	<b>Bias-Down Procedure</b>
<ol style="list-style-type: none"> <li>1. Set <math>V_G</math> to <math>-5</math> V.</li> <li>2. Set <math>I_D</math> limit to 150 mA.</li> <li>3. Apply +32 V to <math>V_D</math>.</li> <li>4. Slowly adjust <math>V_G</math> until <math>I_D</math> is set to 100 mA.</li> <li>5. Set <math>I_D</math> limit to 0.6 A.</li> <li>6. Apply RF.</li> </ol>	<ol style="list-style-type: none"> <li>1. Turn off RF signal.</li> <li>2. Turn off <math>V_D</math>.</li> <li>3. Wait two (2) seconds to allow drain capacitor to discharge.</li> <li>4. Turn off <math>V_G</math>.</li> </ol>